

SM34305D		
Continuous Torque	10.87	in-lb
	174	oz-in
	1.23	N-m
Peak Torque	34.75	in-lb
	556	oz-in
	3.93	N-m
Nominal Continuous Power	400	Watt
No Load Speed	4,100	RPM
Max. Continuous Current* @ 3600 RPM	10.31	Amps
Peak Power @ 2500 RPM	725	Watts
Voltage Constant	12.1	V/kRPM
Inductance	0.490	mH
Encoder Resolution	8,000	Counts/Rev
Rotor Inertia	0.018	oz-in-sec ²
	12.56	10 ⁻⁵ Kg-m ²
Weight	4.5	lb
	2.04	kg
Shaft Diameter	0.375	in
	9.53	mm
Shaft, Radial Load	15	lb
	6.80	kg
Shaft, Axial Thrust Load	3	lb
	1.36	kg
DeviceNet Available	Yes	
PROFIBUS Available		
CANopen Available	Yes	

*Default voltage is 48V. See graphs for additional voltages.



Operating temperature range: 0°C–85°C
Storage temperature range: -10°C–85°C, noncondensing

NOTE: Motor specifications are subject to changes without notice. Consult website and factory for latest data.



Moog Animatics SmartMotor SM34305D (No Options) CAD Drawing

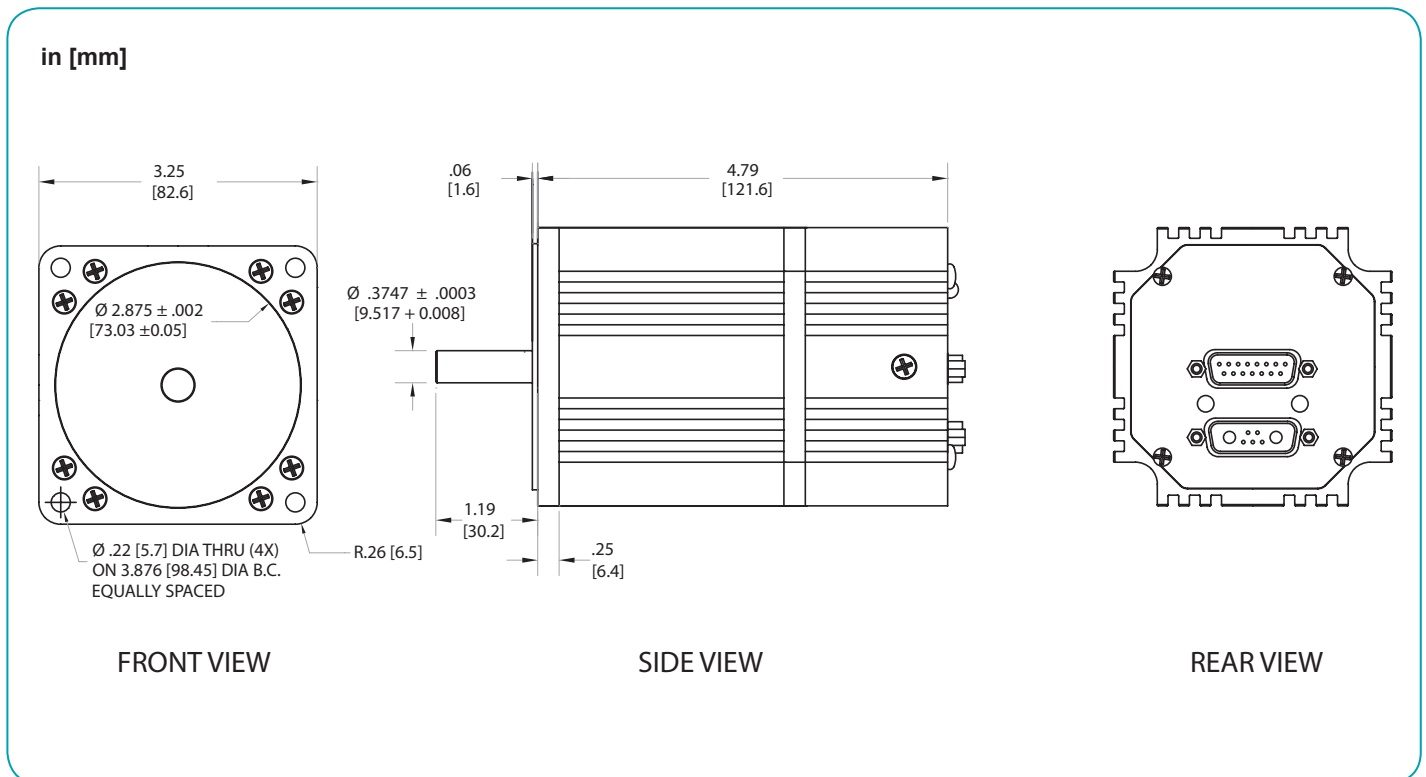

- OVERVIEW
- SOFTWARE
- D-STYLE MOTORS
- D-STYLE CONNECTIVITY
- PERIPHERALS
- M-STYLE MOTORS
- M-STYLE CONNECTIVITY
- LINEAR SYSTEMS
- POWER SUPPLIES & SHUNTS
- GEAR HEADS
- APPENDIX

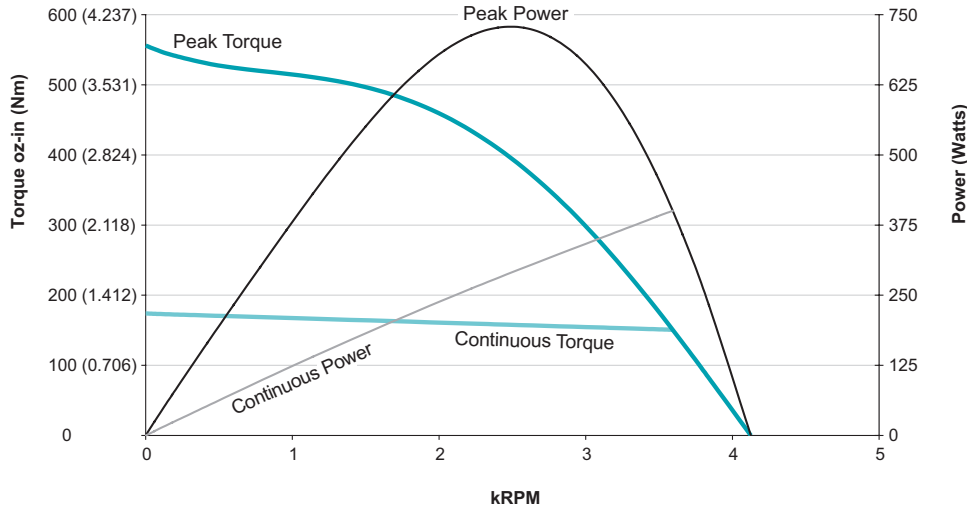

**SM34305D
at 48 VDC
at rise to 85°C**

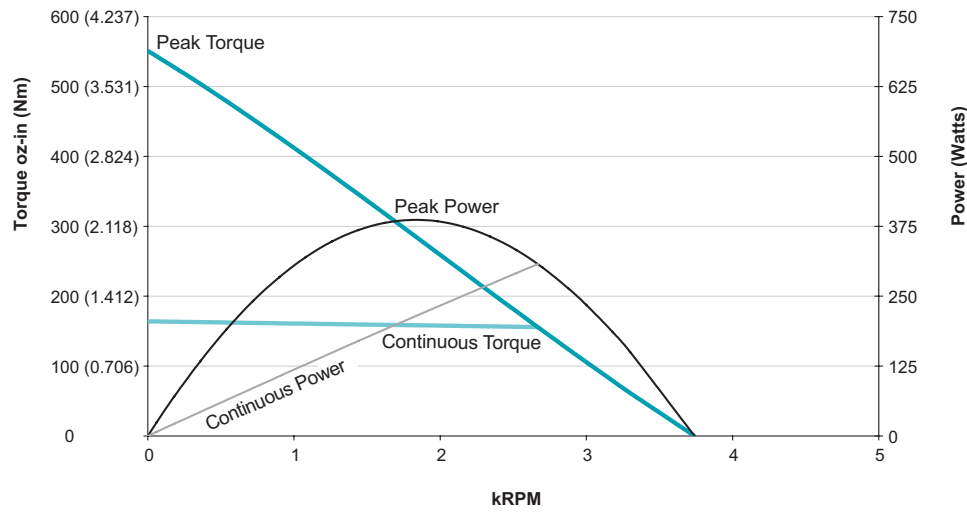

**SM34305D
at 42 VDC
at rise to 85°C**

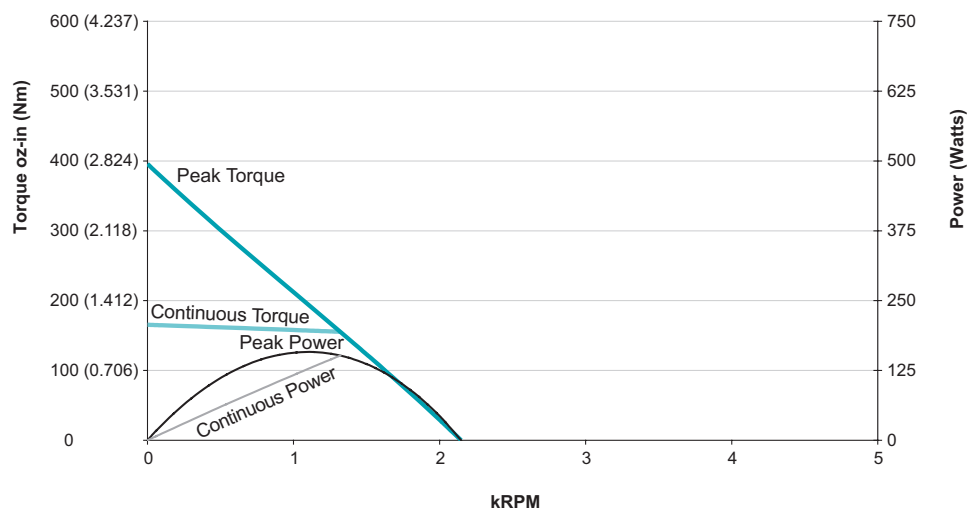

**SM34305D
at 24 VDC
at rise to 85°C**

All torque curves based on 25°C ambient.
Motors were operated using MDT (Trapezoidal Drive Mode) Commutation.
For ambient temperatures above 25°C, Continuous Torque must be linearly derated to 0% at 85°C.