

INSTALLATION AND STARTUP FOR

FULLY INTEGRATED SERVO MOTORS

CLASS 5 LTR (LOW TEMPERATURE
RANGE) SMARTMOTOR™ WITH
COMBITRONIC™ TECHNOLOGY

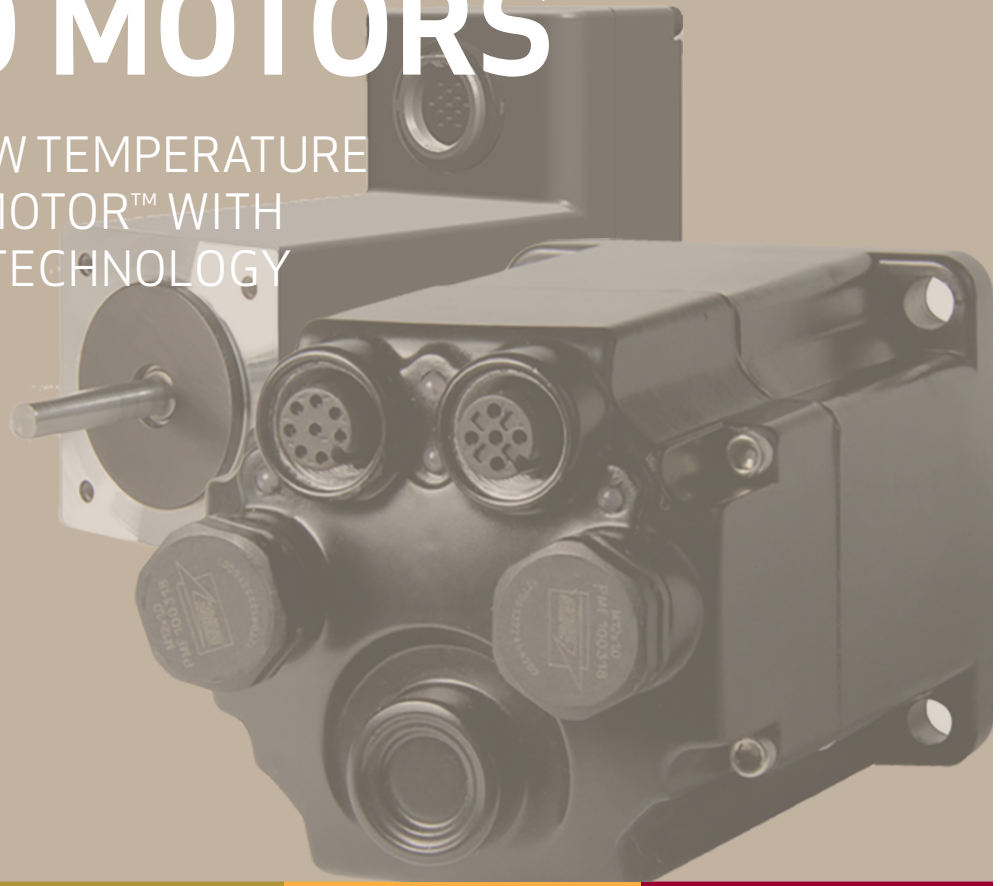

Rev. E, March 2023

DESCRIBES THE INSTALLATION
AND STARTUP OF THE CLASS 5 LTR
SMARTMOTOR™

www.animatics.com

MOOG
 **ANIMATICS**

Copyright Notice

©2014-2023 Moog Inc.

Moog Animatics LTR-Style SmartMotor™ Installation and Startup Guide, Rev. E, PN: SC80100008-001.

This manual, as well as the software described in it, is furnished under license and may be used or copied only in accordance with the terms of such license. The content of this manual is furnished for informational use only, is subject to change without notice and should not be construed as a commitment by Moog Inc., Animatics. Moog Inc., Animatics assumes no responsibility or liability for any errors or inaccuracies that may appear herein.

Except as permitted by such license, no part of this publication may be reproduced, stored in a retrieval system or transmitted, in any form or by any means, electronic, mechanical, recording, or otherwise, without the prior written permission of Moog Inc., Animatics.

The programs and code samples in this manual are provided for example purposes only. It is the user's responsibility to decide if a particular code sample or program applies to the application being developed and to adjust the values to fit that application.

Moog Animatics and the Moog Animatics logo, SmartMotor and the SmartMotor logo, Combitronic and the Combitronic logo are all trademarks of Moog Inc., Animatics. Other trademarks are the property of their respective owners.

Please let us know if you find any errors or omissions in this manual so that we can improve it for future readers. Such notifications should contain the words "LTR-Style Installation and Startup Guide" in the subject line and be sent by e-mail to: animatics_marcom@moog.com. Thank you in advance for your contribution.

Contact Us:

Americas - West

Moog Animatics
2581 Leghorn Street
Mountain View, CA 94043
USA
Tel: 1 650-960-4215

Americas - East

Moog Animatics
1995 NC Hwy 141
Murphy, NC 28906
USA

Support: 1 (888) 356-0357

Website: www.animatics.com

Email: animatics_sales@moog.com

Table Of Contents

Introduction	5
Purpose	6
Safety Information	6
Safety Symbols	6
Other Safety Considerations	6
Motor Sizing	6
Environmental Considerations	7
Machine Safety	7
Documentation and Training	8
Additional Equipment and Considerations	8
Safety Information Resources	8
Additional Documents	10
Related Guides	10
Other Documents	10
Additional Resources	10
SmartMotor Overview	12
SmartMotor Introduction	13
LTR-Style SmartMotor Features and Options	13
LTR-17 SmartMotor Features	14
LTR-23 SmartMotor Features	15
SmartMotor Theory of Operation	17
Getting Started	19
Unpacking and Verifying Your Shipment	21
Installing the SMI Software	21
Installation Procedure	21
Installation Verification	24
Accessing the SMI Software Interface	24
Understanding the Power Requirements	26
Motor Power Requirements	26
Heater Power Requirements	26
CPU, I/O and Communications Power	28
CPU Power Requirements	28
I/O Power Requirements	28
Communications Power Requirements	28

Connecting the System	28
Minimum Requirements	28
LTR-17 Motor Connectors and Pinouts	29
LTR-17 Power, Heater and RS-422 Com Cable Diagram	30
LTR-23 Motor Connectors and Pinouts	31
LTR-23 Power, Heater and RS-422 Com Cable Diagram	32
Maximum Cable Length	33
Understanding the Status LEDs	34
Detecting and Communicating with the SmartMotors	35
Understanding the Detection and Configuration Options	35
Using the Find Motors Button	35
Using the Detect Motors Feature	38
Checking and Clearing the Status Bits	40
Polling the Motor	41
Clearing the Fault Bits	42
Moving the SmartMotor	43
Making the Motor Move	43
Setting and Reporting Torque	44
Checking the Motor Position	45
Viewing the Motor Position with a Report Command	45
Viewing the Motor Position with the Motor View Tool	45
Other LTR-Style Changes	47
Changes to Commutation Modes	47
Features Not Available	47
Commands Not Currently Supported	47
For Further Information...	47
Troubleshooting	48

Introduction

This chapter provides information on the purpose of the manual, safety information, and additional documents and resources.

Purpose	6
Safety Information	6
Safety Symbols	6
Other Safety Considerations	6
Motor Sizing	6
Environmental Considerations	7
Machine Safety	7
Documentation and Training	8
Additional Equipment and Considerations	8
Safety Information Resources	8
Additional Documents	10
Related Guides	10
Other Documents	10
Additional Resources	10

Purpose

NOTE: The LTR-Style SmartMotor™ is intended for RoHS-exempt applications only — the LTR motors contain lead-based solder on some internal components to achieve increased reliability over greater thermal ranges.

The *LTR-Style SmartMotor™ Installation and Startup Guide* (the document you are currently reading) provides an overview of the LTR-Style SmartMotor, along with information on unpacking, installation and start up. This guide is meant to be used in conjunction with the *SmartMotor™ Developer's Guide*, which describes the SmartMotor features, SMI software, programming, commands, and other topics related to SmartMotor application development.

The information in this guide is meant to be used by properly trained technical personnel only. Moog Animatics conducts classroom-style SmartMotor training several times per year, as well as product seminars and other training opportunities. For more information, please see the Moog Animatics website or contact your Moog Animatics representative.

Safety Information

This section describes the safety symbols and other safety information.

Safety Symbols

The manual may use one or more of these safety symbols:



WARNING: This symbol indicates a potentially nonlethal mechanical hazard, where failure to comply with the instructions could result in serious injury to the operator or major damage to the equipment.



CAUTION: This symbol indicates a potentially minor hazard, where failure to comply with the instructions could result in slight injury to the operator or minor damage to the equipment.

NOTE: Notes are used to emphasize non-safety concepts or related information.

Other Safety Considerations

The Moog Animatics SmartMotors are supplied as components that are intended for use in an automated machine or system. As such, it is beyond the scope of this manual to attempt to cover all the safety standards and considerations that are part of the overall machine/system design and manufacturing safety. Therefore, this information is intended to be used only as a general guideline for the machine/system designer.

It is the responsibility of the machine/system designer to perform a thorough "Risk Assessment" and to ensure that the machine/system and its safeguards comply with the safety standards specified by the governing authority (for example, ISO, OSHA, UL, etc.) for the site where the machine is being installed and operated. For more details, see Machine Safety on page 7.

Motor Sizing

It is the responsibility of the machine/system designer to select SmartMotors that are properly sized for the specific application. Undersized motors may: perform poorly, cause excessive downtime or cause unsafe operating conditions by not being able to handle the loads placed on them. The *System*

Best Practices document, which is available on the Moog Animatics website, contains information and equations that can be used for selecting the appropriate motor for the application.

Replacement motors must have the same specifications and firmware version used in the approved and validated system. Specification changes or firmware upgrades require the approval of the system designer and may require another Risk Assessment.

Environmental Considerations

It is the responsibility of the machine/system designer to evaluate the intended operating environment for dust, high-humidity or presence of water (for example, a food-processing environment that requires water or steam wash down of equipment), corrosives or chemicals that may come in contact with the machine, etc. Moog Animatics manufactures specialized IP-rated motors for operating in extreme conditions. For details, see the *Moog Animatics Product Catalog*.

Machine Safety

In order to protect personnel from any safety hazards in the machine or system, the machine/system builder must perform a "Risk Assessment", which is often based on the ISO 13849 standard. The design/implementation of barriers, emergency stop (E-stop) mechanisms and other safeguards will be driven by the Risk Assessment and the safety standards specified by the governing authority (for example, ISO, OSHA, UL, etc.) for the site where the machine is being installed and operated. The methodology and details of such an assessment are beyond the scope of this manual. However, there are various sources of Risk Assessment information available in print and on the internet.

NOTE: The next list is an example of items that would be evaluated when performing the Risk Assessment. Additional items may be required. The safeguards must ensure the safety of all personnel who may come in contact with or be in the vicinity of the machine.

In general, the machine/system safeguards must:

- Provide a barrier to prevent unauthorized entry or access to the machine or system. The barrier must be designed so that personnel cannot reach into any identified danger zones.
- Position the control panel so that it is outside the barrier area but located for an unrestricted view of the moving mechanism. The control panel must include an E-stop mechanism. Buttons that start the machine must be protected from accidental activation.
- Provide E-stop mechanisms located at the control panel and at other points around the perimeter of the barrier that will stop all machine movement when tripped.
- Provide appropriate sensors and interlocks on gates or other points of entry into the protected zone that will stop all machine movement when tripped.
- Ensure that if a portable control/programming device is supplied (for example, a hand-held operator/programmer pendant), the device is equipped with an E-stop mechanism.

NOTE: A portable operation/programming device requires *many* additional system design considerations and safeguards beyond those listed in this section. For details, see the safety standards specified by the governing authority (for example, ISO, OSHA, UL, etc.) for the site where the machine is being installed and operated.

- Prevent contact with moving mechanisms (for example, arms, gears, belts, pulleys, tooling, etc.).
- Prevent contact with a part that is thrown from the machine tooling or other part-handling equipment.
- Prevent contact with any electrical, hydraulic, pneumatic, thermal, chemical or other hazards that may be present at the machine.
- Prevent unauthorized access to wiring and power-supply cabinets, electrical boxes, etc.

- Provide a proper control system, program logic and error checking to ensure the safety of all personnel and equipment (for example, to prevent a run-away condition). The control system must be designed so that it does not automatically restart the machine/system after a power failure.
- Prevent unauthorized access or changes to the control system or software.

Documentation and Training

It is the responsibility of the machine/system designer to provide documentation on safety, operation, maintenance and programming, along with training for all machine operators, maintenance technicians, programmers, and other personnel who may have access to the machine. This documentation must include proper lockout/tagout procedures for maintenance and programming operations.

It is the responsibility of the operating company to ensure that:

- All operators, maintenance technicians, programmers and other personnel are tested and qualified before acquiring access to the machine or system.
- The above personnel perform their assigned functions in a responsible and safe manner to comply with the procedures in the supplied documentation and the company safety practices.
- The equipment is maintained as described in the documentation and training supplied by the machine/system designer.

Additional Equipment and Considerations

The Risk Assessment and the operating company's standard safety policies will dictate the need for additional equipment. In general, it is the responsibility of the operating company to ensure that:

- Unauthorized access to the machine is prevented at all times.
- The personnel are supplied with the proper equipment for the environment and their job functions, which may include: safety glasses, hearing protection, safety footwear, smocks or aprons, gloves, hard hats and other protective gear.
- The work area is equipped with proper safety equipment such as first aid equipment, fire suppression equipment, emergency eye wash and full-body wash stations, etc.
- There are no modifications made to the machine or system without proper engineering evaluation for design, safety, reliability, etc., and a Risk Assessment.

Safety Information Resources

Additional SmartMotor safety information can be found on the Moog Animatics website; open the topic "Controls - Notes and Cautions" located at:

<https://www.animatics.com/support/downloads/knowledgebase/controls---notes-and-cautions.html>

OSHA standards information can be found at:

<https://www.osha.gov/law-regs.html>

ANSI-RIA robotic safety information can be found at:

<http://www.robotics.org/robotic-content.cfm/Robotics/Safety-Compliance/id/23>

UL standards information can be found at:

<http://ulstandards.ul.com/standards-catalog/>

ISO standards information can be found at:

<http://www.iso.org/iso/home/standards.htm>

EU standards information can be found at:

http://ec.europa.eu/growth/single-market/european-standards/harmonised-standards/index_en.htm

Additional Documents

The Moog Animatics website contains additional documents that are related to the information in this manual. Please refer to these lists.

Related Guides

- Moog Animatics SmartMotor™ Installation and Startup Guides
<http://www.animatics.com/install-guides>
- *Class 6 D-Style SmartMotor™ Installation and Startup Guide*
<http://www.animatics.com/cl-6-d-style-install-startup-guide>
- *SmartMotor™ Developer's Guide*
<http://www.animatics.com/smartmotor-developers-guide>
- *SmartMotor™ Homing Procedures and Methods Application Note*
<http://www.animatics.com/homing-application-note>
- *SmartMotor™ System Best Practices Application Note*
<http://www.animatics.com/system-best-practices-application-note>

In addition to the documents listed above, guides for fieldbus protocols and more can be found on the website: <https://www.animatics.com/support/downloads/manuals.html>

Other Documents

- SmartMotor™ Certifications
<https://www.animatics.com/certifications.html>
- *SmartMotor Developer's Worksheet*
(interactive tools to assist developer: Scale Factor Calculator, Status Words, CAN Port Status, Serial Port Status, RMODE Decoder and Syntax Error Codes)
<https://www.animatics.com/support/downloads/knowledgebase.html>
- *Moog Animatics Product Catalog*
<http://www.animatics.com/support/moog-animatics-catalog.html>

Additional Resources

The Moog Animatics website contains useful resources such as product information, documentation, product support and more. Please refer to these addresses:

- General company information:
<http://www.animatics.com>
- Product information:
<http://www.animatics.com/products.html>
- Product support (Downloads, How-to Videos, Forums and more):
<http://www.animatics.com/support.html>
- Contact information, distributor locator tool, inquiries:
<https://www.animatics.com/contact-us.html>
- Applications (Application Notes and Case Studies):
<http://www.animatics.com/applications.html>

SmartMotor Overview

This chapter provides an overview of the design philosophy and functionality of the Moog Animatics SmartMotor. It also provides information on SmartMotor features and options, and where to find related documents and additional resources.

SmartMotor Introduction	13
LTR-Style SmartMotor Features and Options	13
LTR-17 SmartMotor Features	14
LTR-23 SmartMotor Features	15
SmartMotor Theory of Operation	17

SmartMotor Introduction

The Moog Animatics SmartMotor™ servo is an industrial servo motor with motion controller integrated into a compact package. Its design is based on these objectives:

1. Reduce development time
2. Lower machine-production cost
3. Simplify the machine (design, build and support)



Class 5 LTR-17 and LTR-23 SmartMotor

The SmartMotor is powerful and unique because of its ability to control an entire machine. The combination of programmability, networking, I/O and servo performance is unmatched. The SmartMotor brings savings and value to the machine builder by removing complex and costly elements in the machine design, such as PLCs, sensors, I/O blocks, cabinets, etc.

LTR-Style SmartMotor Features and Options

NOTE: The LTR-Style SmartMotor™ is intended for RoHS-exempt applications only — the LTR motors contain lead-based solder on some internal components to achieve increased reliability over greater thermal ranges.

NOTE: All specifications are subject to change without notice. Consult the factory for the latest information.

The following sections describe the features and options available on the LTR-style SmartMotors.

A note about SmartMotor part numbers:

The SmartMotor uses a coded part number, which contains characters that describe the motor number, frame style and options. For details on decoding the SmartMotor part number, refer to the Understanding SmartMotor Part Numbers document at this address:

<https://www.animatics.com/support/downloads.knowledgebase.html>

LTR-17 SmartMotor Features

NOTE: The LTR-17 SmartMotor requires firmware version 5.26.3.10 or later.

The SmartMotor is available in a Low Temperature Range (LTR), NEMA 17 configuration, which is called the LTR-17 SmartMotor. All LTR-17 motors have these features:

- IP62 rated, high-altitude operation
- Temperature information:
 - Maximum internal temperature: 85°C at electronics, 130°C at windings
 - Operating temperature range: -55°C to 70°C
 - NOTE:** The internal circuit must be at -40°C or higher to establish communication. For details, see Heater Power Requirements on page 26.
 - Storage temperature range: -65°C to 85°C
- Low-temp startup with onboard heater to raise circuit temperature from -65°C to -40°C
- Ports: One 13-pin connector that handles all power and I/O
 - NOTE:** Only one LTR-style motor can be attached to a serial port. The LTR-style motors do not support daisy-chain installation (multiple motors on the same network).
- LEDs: Two bi-colored LED indicators to show error codes, status and communications activity
- Magnetic, single-turn absolute encoder
- Four 5V TTL sourcing inputs
- Push-on / pull-off, IP67-rated connector



CAUTION: connectors must be finger tightened only! DO NOT use a wrench or other tool. Doing so can cause overtightening of the connection, which may damage the connector and will void the warranty.

- RS-422 differential communication

NOTE: The LTR-Style SmartMotor™ is intended for RoHS-exempt applications only — the LTR motors contain lead-based solder on some internal components to achieve increased reliability over greater thermal ranges.

The next figure shows the connector and LED locations for the LTR-17 SmartMotor. For details on the motor connectors, see [Connecting the System](#) on page 28. For details on the LED functions, see [Understanding the Status LEDs](#) on page 34.

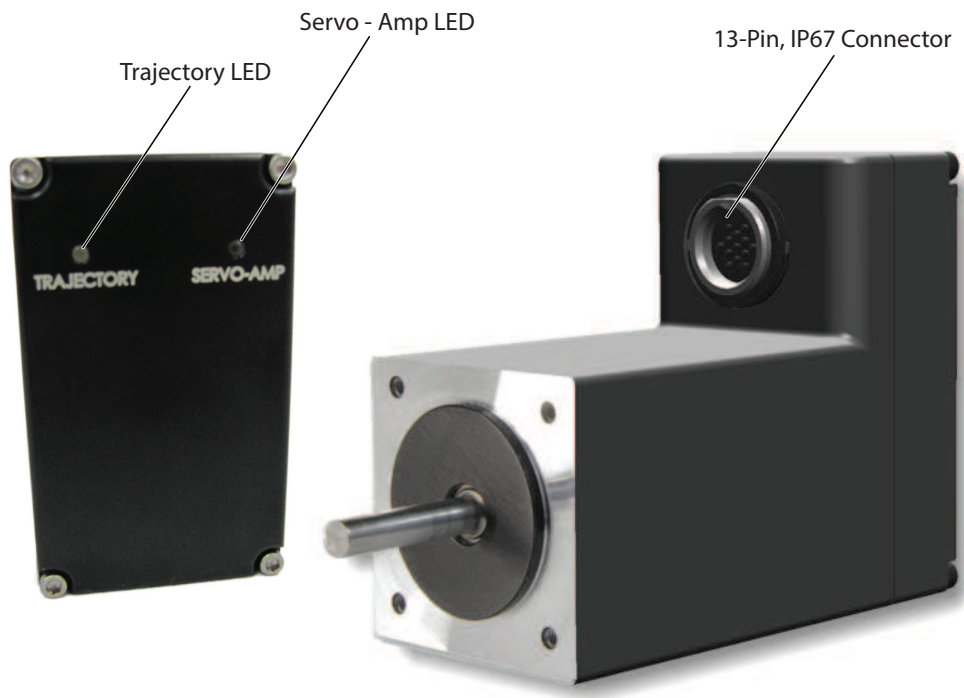

LTR-17 SmartMotor Connector and LEDs

LTR-23 SmartMotor Features

NOTE: The LTR-23 SmartMotor requires firmware version 5.26.3.10 or later.

The SmartMotor is available in a Low Temperature Range (LTR), NEMA 23 configuration, which is called the LTR-23 SmartMotor. All LTR-23 motors have these features:

- IP65 rated, high-altitude operation

NOTE: After a five-minute warmup, IP67 is possible with a fluorsilicone O-ring installed between the motor flange and an IP67-rated mating component (contact the factory for more details).
- Temperature information:
 - Maximum internal temperature: 85°C at electronics, 130°C at windings
 - Operating temperature range: -55°C to 70°C

NOTE: The internal circuit must be at -40°C or higher to establish communication. For details, see [Heater Power Requirements](#) on page 26.
 - Storage temperature range: -65°C to 85°C
- Low-temp startup with onboard heater to raise circuit temperature from -65°C to -40°C

- Ports: One 8-pin connector that handles all power and communications; one 5-pin connector that handles I/O.

NOTE: Only one LTR-style motor can be attached to a serial port. The LTR-style motors do not support daisy-chain installation (multiple motors on the same network).

- LEDs: Two bi-colored LED indicators to show error codes, status and communications activity
- Magnetic, single-turn absolute encoder
- Three 5V TTL sourcing inputs
- M-style connectors



CAUTION: connectors must be finger tightened only! DO NOT use a wrench or other tool. Doing so can cause overtightening of the connection, which may damage the connector and will void the warranty.

- RS-422 differential communication

NOTE: The LTR-Style SmartMotor™ is intended for RoHS-exempt applications only — the LTR motors contain lead-based solder on some internal components to achieve increased reliability over greater thermal ranges.

The next figure shows the connector and LED locations for the LTR-23 SmartMotor. For details on the motor connectors, see Connecting the System on page 28. For details on the LED functions, see Understanding the Status LEDs on page 34.

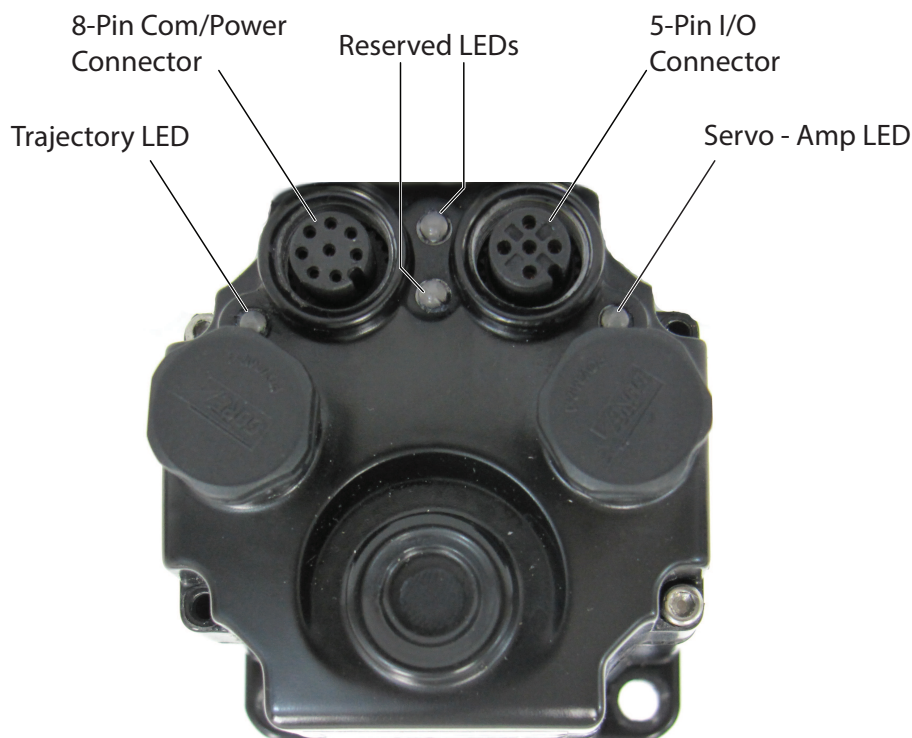

LTR-23 SmartMotor Connector and LEDs

SmartMotor Theory of Operation

The Moog Animatics SmartMotor is an entire servo control system built inside of a servo motor. It includes a controller, an amplifier and an encoder. All that is required for it to operate is power and either an internal program or serial commands from outside (or both). To make the SmartMotor move, the program or serial host must set a mode of operation, state a target position with/or a maximum velocity at which to travel to that target, and a maximum acceleration. After these three parameters are set, a "Go" command starts the motion profile.

The core functional areas of the SmartMotor are:

- Motion Control Functions (see Motion Details in the *SmartMotor™ Developer's Guide*)
- System Control Functions (see Program Flow Details and see System Status in the *SmartMotor™ Developer's Guide*)
- Communication Functions (see Communication Details in the *SmartMotor™ Developer's Guide*)
- I/O Functions (see I/O Control in the *SmartMotor™ Developer's Guide*)

The next block diagram illustrates the relationship between the functional areas in the SmartMotor.

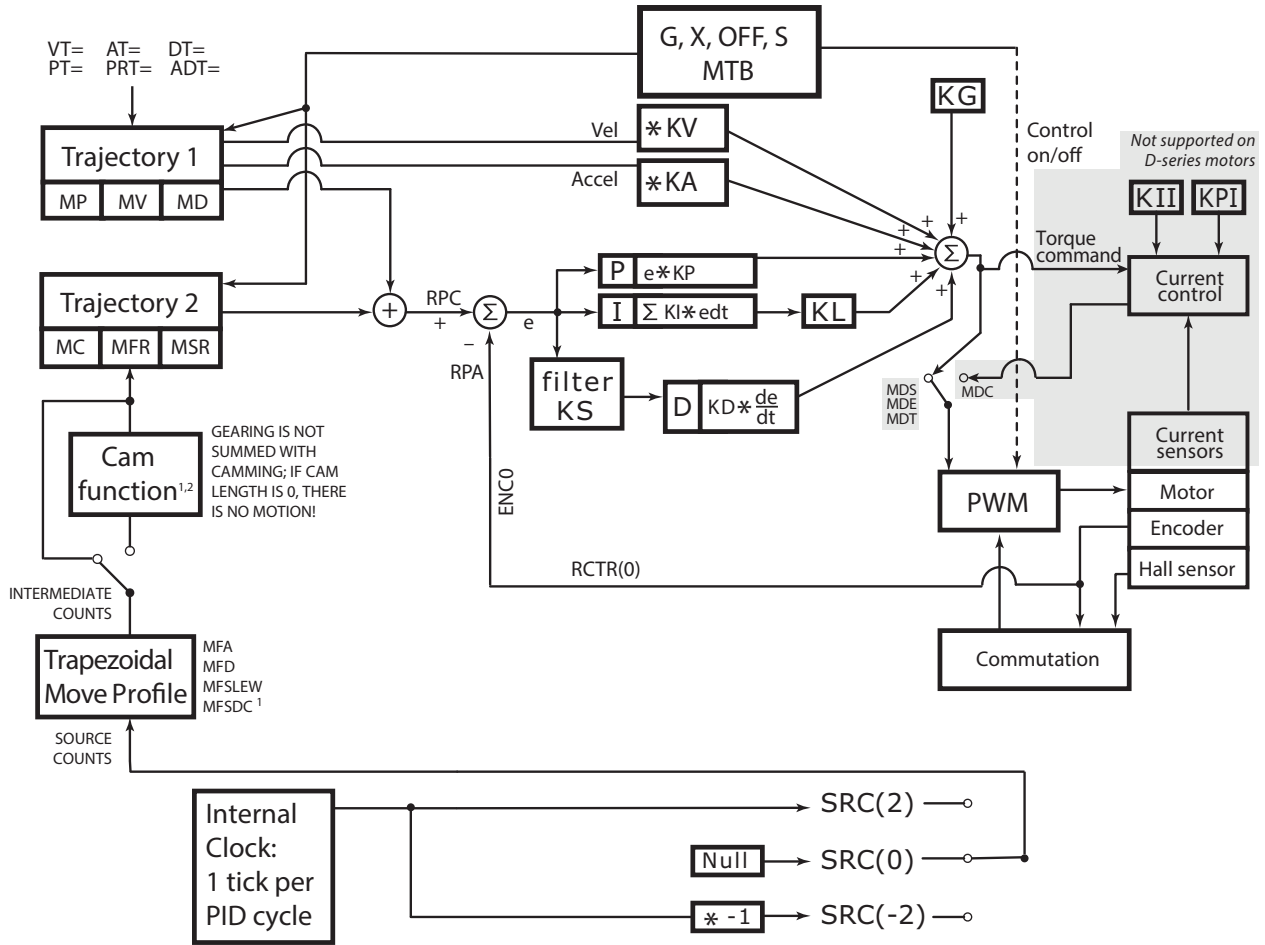

NOTES:

1. MFMUL and MFDIV commands do not have an effect on dwell time or distance. Dwell is strictly based on raw controller1 encoder counts selected by the SRC() command specifying internal virtual controller count source.
2. When feeding a Cam table with a gearing profile, changes to MFMUL and MFDIV will affect the time it takes to move through a Cam table but will not affect dwell time, as specified in the previous note.

SmartMotor Theory of Operation Diagram

¹Moog Animatics has replaced the terms "master" and "slave" with "controller" and "follower", respectively.

Getting Started

This chapter provides information on getting started with your SmartMotor.

Unpacking and Verifying Your Shipment	21
Installing the SMI Software	21
Installation Procedure	21
Installation Verification	24
Accessing the SMI Software Interface	24
Understanding the Power Requirements	26
Motor Power Requirements	26
Heater Power Requirements	26
CPU, I/O and Communications Power	28
CPU Power Requirements	28
I/O Power Requirements	28
Communications Power Requirements	28
Connecting the System	28
Minimum Requirements	28
LTR-17 Motor Connectors and Pinouts	29
LTR-17 Power, Heater and RS-422 Com Cable Diagram	30
LTR-23 Motor Connectors and Pinouts	31
LTR-23 Power, Heater and RS-422 Com Cable Diagram	32
Maximum Cable Length	33
Understanding the Status LEDs	34
Detecting and Communicating with the SmartMotors	35
Understanding the Detection and Configuration Options	35
Using the Find Motors Button	35
Using the Detect Motors Feature	38
Checking and Clearing the Status Bits	40
Polling the Motor	41
Clearing the Fault Bits	42
Moving the SmartMotor	43
Making the Motor Move	43
Setting and Reporting Torque	44

Checking the Motor Position	45
Viewing the Motor Position with a Report Command	45
Viewing the Motor Position with the Motor View Tool	45

Unpacking and Verifying Your Shipment

Your Moog Animatics SmartMotor and accessories are carefully assembled, tested, inspected and packed at the factory.

When you receive your shipment, you should:

- Visually inspect all shipping containers for visible signs of shipping damage. If you see damage, please notify your carrier and then contact Moog Animatics to report the problem.
- Carefully unpack each component and verify the part number with your order. If there are any differences or missing items, please contact Moog Animatics so that the shipment can be corrected.
- Keep all boxes and packing materials. These may be needed for future storage or shipment of the equipment.

Installing the SMI Software

The SmartMotor Interface software (SMI software) provides a convenient user interface for programming the SmartMotor. Before you can use the SMI software, it must be installed on a Microsoft Windows PC.

The SMI software is distributed on CD-ROM or USB stick, and is also available as a download from the Moog Animatics website. To download the latest version of the SMI software, use this address:

<http://www.animatics.com/smi>

Then scroll to the bottom of the page and click the Free Download button.

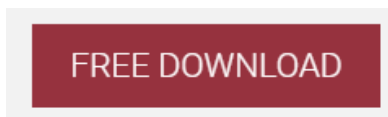

SMI Download Button

The installation package is downloaded to your system.

NOTE: The SMI software requires Microsoft Windows XP or later.

Installation Procedure

NOTE: Depending on the SMI software version and SmartMotor model being used, the software version and motor information may be different on your screens.

To install the SMI software:

1. Double-click the executable package (.MSI) file to begin the installation. In some versions of Microsoft Windows, you may receive a security warning message about running the file. You can ignore this message.

If this is a new installation, go to the next step.

If this is an upgrade to a previous installation, you will see the window below. Select Remove, click Next and remove the existing software from your PC using the instructions.

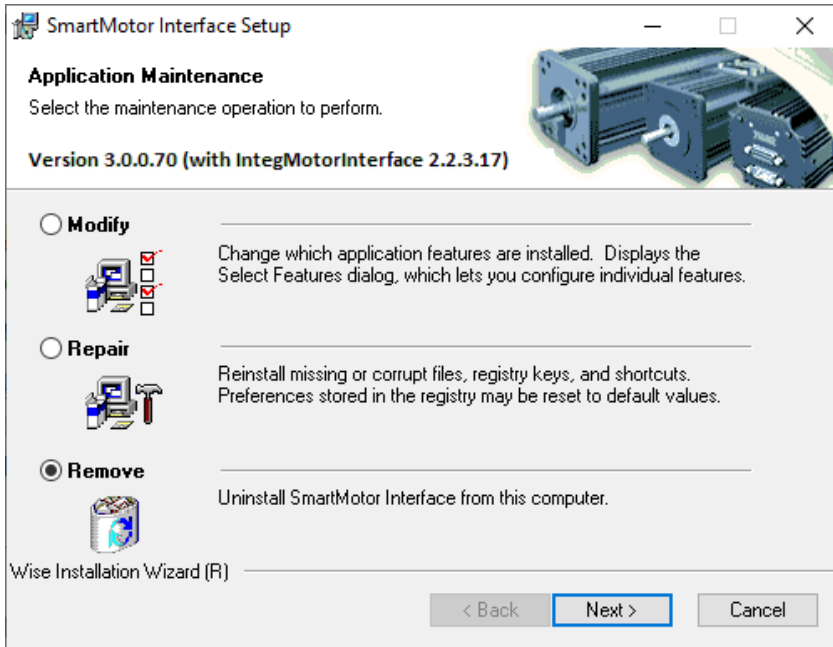

After removing the existing software, restart the installation process.

NOTE: All personal settings and user files will be retained.

2. Click Next to proceed. The Installation Configuration page opens.

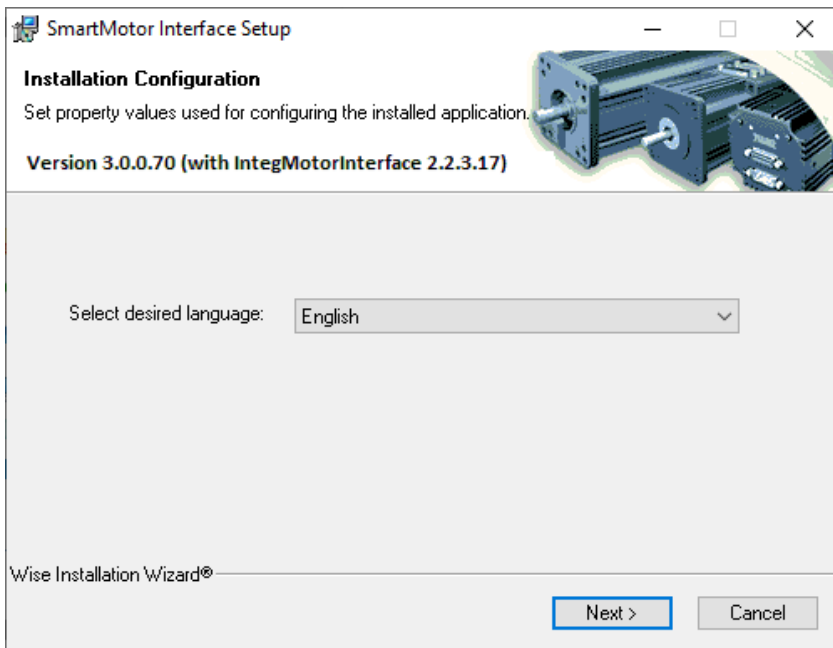

3. Click Next to proceed. The SMI software installation wizard starts and the Welcome page opens.

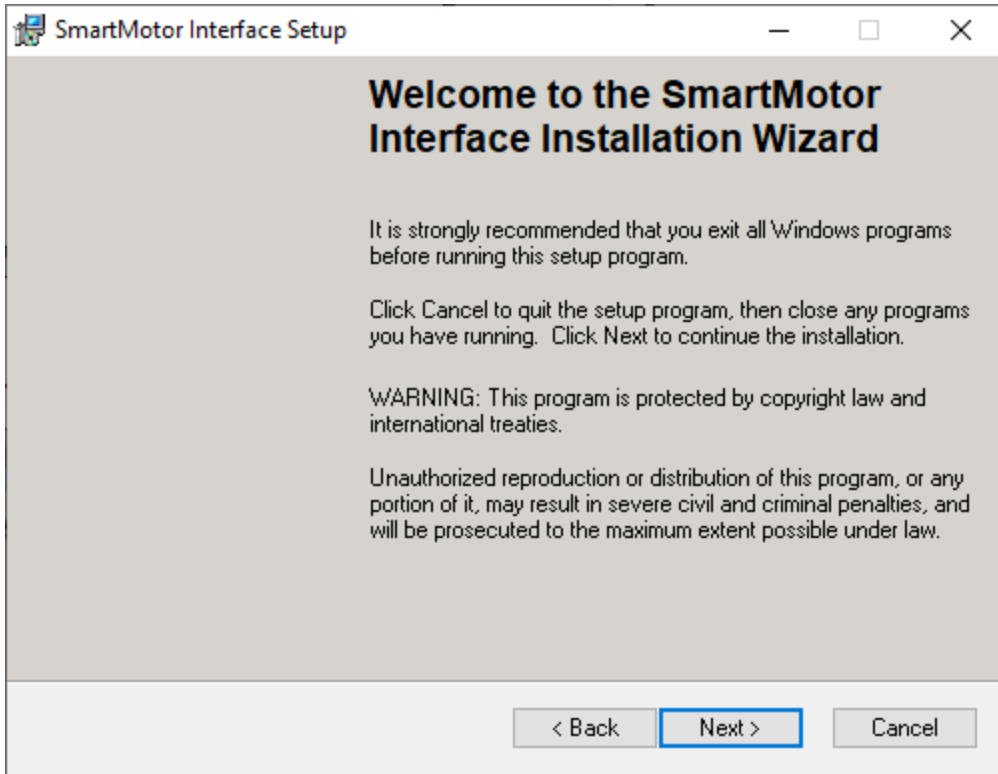

4. After you have finished reviewing the welcome information, click Next to proceed. Use the on-screen instructions to complete the SMI software installation.

- When the installation has completed, the installation status message page opens, as shown in the next figure. Click Finish to complete the installation and close the installation wizard.

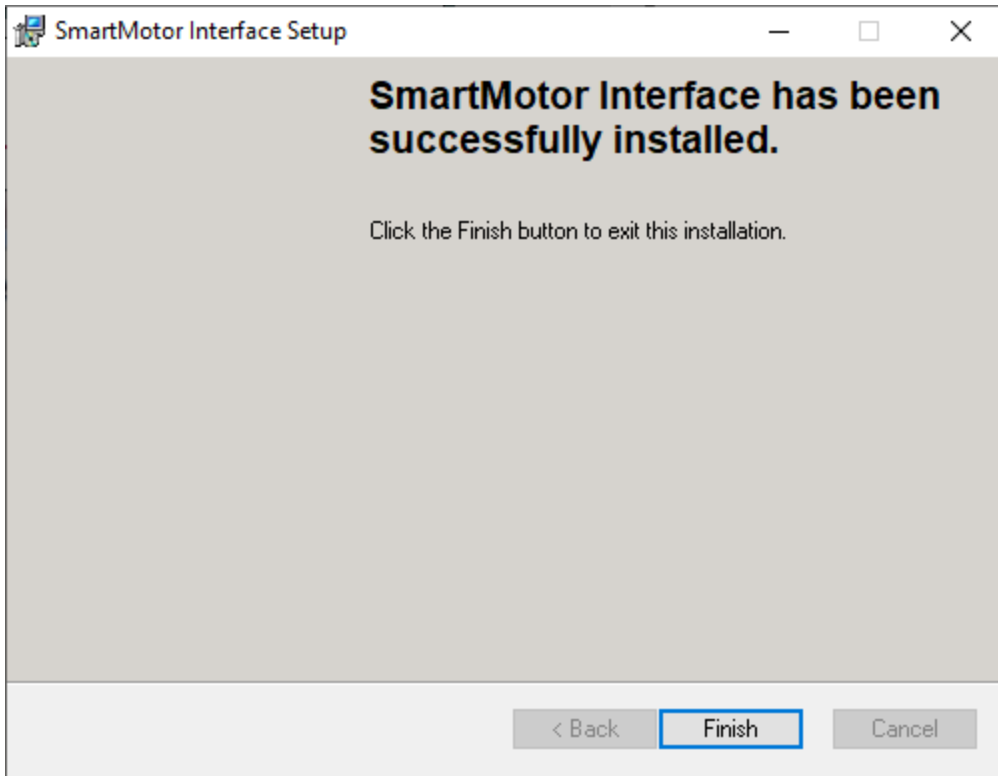

NOTE: After the software is installed, be sure to restart your computer before running the SMI software.

Installation Verification

To verify the installation, navigate to the C:\Program Files (or folder C:\Program Files x86) folder. You should see these folders:

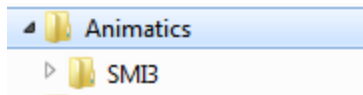

Accessing the SMI Software Interface

The SmartMotor Interface software (SMI software) communicates with a single or series of SmartMotors from a Windows-based PC and gives you the capability to control and monitor the status of the motors. The SMI software also allows you to write programs and download them into the SmartMotor's long-term memory.

NOTE: Every SmartMotor has an ASCII interpreter built in. Therefore, it is not necessary to use the SMI software to operate a SmartMotor.

To open the SMI software, double-click the SmartMotor Interface shortcut on the Windows desktop.



SmartMotor Interface Shortcut

Optionally, to open the SMI software from the Microsoft Windows Start menu, select:

Start > All Programs > Animatics > SMI3 > SmartMotor Interface

The SMI software interface opens, as shown in the next figure.

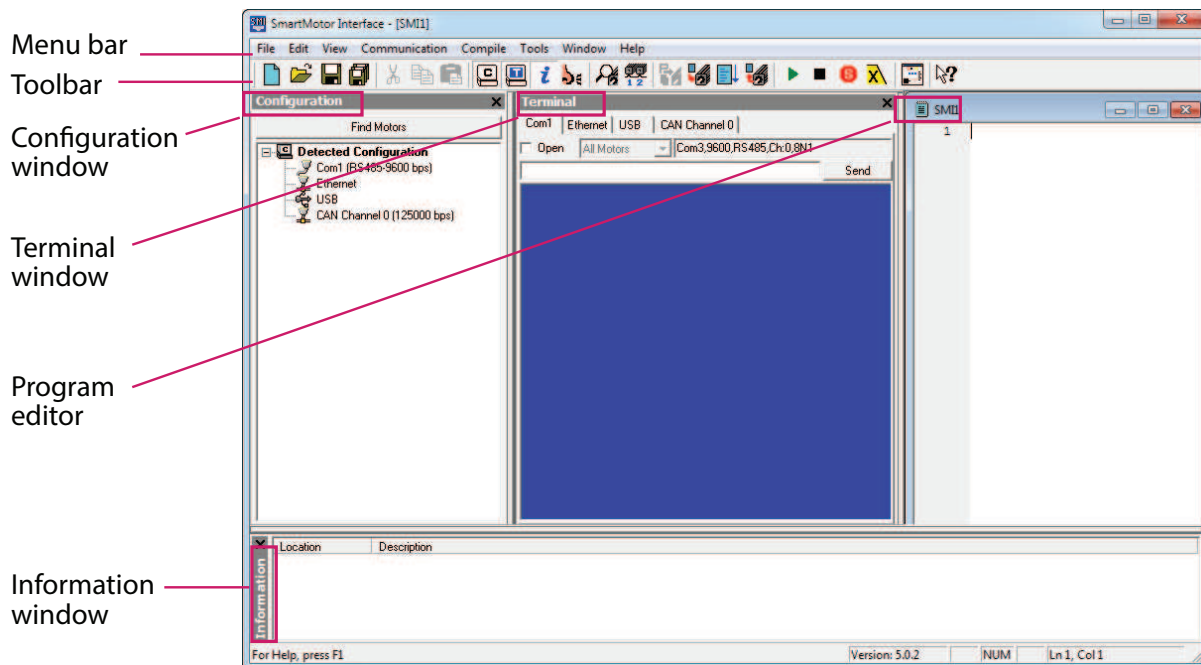

SMI Software Interface

NOTE: In addition to the software information in this section, there is context-sensitive help available within the SMI software interface, which is accessed by pressing the F1 key or selecting Help from the SMI software main menu.

These are the primary features in this interface:

- **Menu Bar:** All of the windows and functions of the SMI software can be accessed through the menu bar. Many of these are also accessible through the icons on the toolbar.
- **Toolbar:** The toolbar contains a collection of icons for accessing the primary features of the SMI software. Depending on the current state of the SMI software and the currently-active window, some toolbar buttons may be disabled.
- **Configuration Window (far-left window):** This window is used to display the current communication and detected motor configuration when no project is open, or the communication and motor configuration defined in an open project.
- **Terminal Window (middle window):** This window is used to communicate with SmartMotors (for example, issue single-line commands to one or all motors). The response (if any) is also shown in this window.
- **Information Window (lower window):** This window is used to display the results of user operations.
- **Program Editor (far-right window):** This window is used to manage, edit and print user programs. Most of the procedures for using the editor should seem familiar if you have used other Windows-based text editors.

For more details about these items, see the SMI software online help, which can be viewed in SMI by pressing F1 or selecting Help > Contents - SMI Software Help.

Understanding the Power Requirements

This section describes the power requirements for Class 5 LTR-style SmartMotor power, CPU power, I/O power and Communications power.

Motor Power Requirements

Requirement:

For LTR-style SmartMotors: motor power requires nominal 48 VDC and is operational from 40 to 50 VDC. Do not exceed 50 VDC.

NOTE: It is recommended that motor power and heater power have dedicated (separate) power supplies.



CAUTION: Voltages outside of the stated range may damage the motor circuit or impair its performance.

Control (CPU) power is internally supplied off the main motor power. Unlike other SmartMotors, there are no separate control power input pins.

Details: These SmartMotors can draw high current. At least 14 AWG wire is recommended for powering the SmartMotor.

Voltages below 40 VDC could cause a brownout shutdown of the CPU, or what would appear as a power-off reset, under sudden load changes.



CAUTION: If power is reversed on any standard SmartMotors, immediate damage WILL occur and the SmartMotor will no longer operate.

When relying on torque/speed curves, pay close attention to the voltage on which they are based.

During hard, fast decelerations, a SmartMotor can pull up supply voltages to the point of damage if a shunt resistor pack is not used. Protective shunts are available from Moog Animatics.

Special care must be taken when near the upper voltage limit or in vertical applications that can back-drive the SmartMotor. Gravity-influenced applications can turn the SmartMotor into a generator and back-drive the power supply voltage above the safe limit for the SmartMotor. Many vertical applications require a shunt to protect the SmartMotor from damage. Protective shunts are available from Moog Animatics.



CAUTION: Many vertical applications and applications with hard, fast decelerations require shunts to protect the SmartMotor from damage. Note that shunts should always be placed between the motor input and any disconnect or E-stop relay to protect the motor when power is off or E-stop relay contacts are open.

Heater Power Requirements

On LTR-style SmartMotors, built-in heaters can be used to raise the CPU board temperature when it drops below -40 degrees C. This allows the SmartMotor to start up in extremely cold environments. After the motor is running, the heaters are not required. The heaters will warm only the circuit board and will not warm any mechanical parts, such as the bearings or shaft.

Requirement:

For LTR-style SmartMotors: heater power requires nominal 48 VDC and is operational from 40 to 50 VDC. Do not exceed 50 VDC.

NOTE: It is recommended that motor power and heater power have dedicated (separate) power supplies.



CAUTION: Voltages outside of the stated range may damage the heater circuit or impair its performance.

The heater power is externally supplied and controlled by the user. It should only be operated between -65 degrees C and 0 degrees C, the target temperature for activating the heater is -40 degrees C or below. The length of time to operate the heater is proportional to how long the motor has been powered off in a -40 degrees C (or below) environment. The test of proper board temperature is to try to communicate with the motor—if you can, then the board has reached operating temperature.



CAUTION: It is the user's responsibility to externally control the heater, and warm the board to -40 degrees C or higher to establish communication with the SmartMotor. Only operate the heater between -65 degrees C and 0 degrees C; ensure the heater is off at 0 degrees C. Application of the heater above 0 degrees C can damage the motor.

Follow this procedure:

1. Measure the ambient air temperature in the vicinity of the motor. If the ambient temperature is at or below -40 degrees C then the heater can be activated as follows:
 - If the motor has been powered off and at or below -40 degrees C for two or more hours, the heater should be operated for approximately 5 minutes. This will raise the internal circuit board to operating temperature.
 - If the motor has been powered off and at or below -40 degrees C for less than two hours, the heater should be operated for less than five minutes, gauging the time proportionally, based on how long the motor has been powered off and at or below -40 degrees C.
2. Power on the motor and attempt to establish communications.
 - If you are able to establish communications with the motor, the internal circuit is warm enough. Proceed to the next step.
 - If you are unable to establish communications with the motor, the internal circuit requires additional heating—continue heating in 30 second intervals and retest until you can establish communications. Proceed to the next step.
3. After communications are established, use the TEMP command to monitor the internal circuit board temperature. For details, see the *SmartMotor™ Developer's Guide*.
4. Deactivate the heater before the board temperature reaches 0 degrees C.



CAUTION: Never operate the heater when the board temperature is at 0 degrees C or higher, as this can damage the motor.

CPU, I/O and Communications Power

This section describes the requirements for CPU, I/O and Communications power. For information on how the SmartMotors handle voltage spikes on the I/O line, see I/O Voltage Spikes in the *SmartMotor™ Developer's Guide*.

CPU Power Requirements

Requirement: The CPU is powered from the "motor" power input.

Details: The CPU is powered from the "motor" power input (pin 1 on the LTR-17 motor 13-pin connector; pin 7 on the LTR-23 motor 8-pin connector). The supply must be from 40 to 50 VDC, as this input cannot handle a higher voltage. To achieve optimum motor torque, use nominal 48 VDC.

I/O Power Requirements

Requirement: The I/O is powered from the "motor" power input.

There are three input ports. Each of these inputs is 5 VDC max. These three ports can be configured as analog to digital converter (ADC) and can handle an input from 0 to 5 VDC. The motor's ADC sample resolution is 10 bits.

Details: The I/O is powered from the "motor" power input (pin 1 on the LTR-17 motor 13-pin connector; pin 7 on the LTR-23 motor 8-pin connector). The supply must be from 40 to 50 VDC, as this input cannot handle a higher voltage. To achieve optimum motor torque, use nominal 48 VDC.

NOTE: This I/O is not isolated from the CPU's power supply and the motor drive.

Communications Power Requirements

Requirement: The RS-422 signal is powered from the "motor" power input.

Details: The RS-422 signal is powered from the "motor" power input (pin 1 on the LTR-17 motor 13-pin connector; pin 7 on the LTR-23 motor 8-pin connector). The supply must be from 40 to 50 VDC, as this input cannot handle a higher voltage. To achieve optimum motor torque, use nominal 48 VDC.

NOTE: The RS-422 signal is not isolated from the CPU's power supply or the motor drive.

Connecting the System

These sections show system connections and cable diagrams for typical installations.

NOTE: Only one LTR-style motor can be attached to a serial port. The LTR-style motors do not support daisy-chain installation (multiple motors on the same network).

Minimum Requirements

At minimum, you will need these items:

1. An LTR-17 or LTR-23 SmartMotor
2. A computer running Microsoft Windows and the SMI software
3. Power and data cables for the SmartMotor
4. Power supplies (for power requirements, see Understanding the Power Requirements on page 26)

NOTE: It is recommended that motor power and heater power have dedicated (separate) power supplies.

LTR-17 Motor Connectors and Pinouts

The next figure provides an overview of the connectors and pinouts available on the LTR-17 SmartMotors.

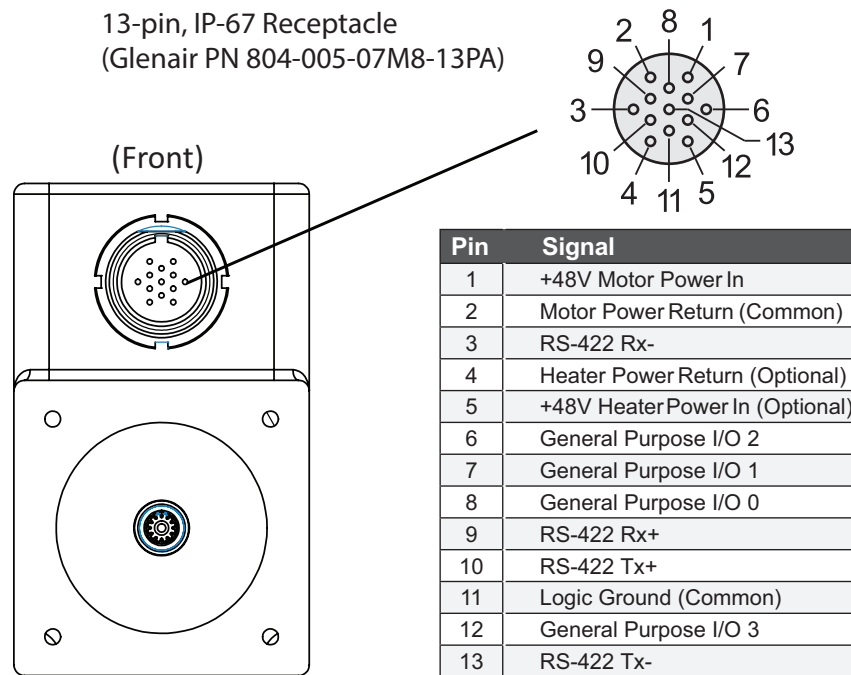

CAUTION: connectors must be finger tightened only! DO NOT use a wrench or other tool. Doing so can cause overtightening of the connection, which may damage the connector and will void the warranty.

The next table provides information on the mating connector for the 13-pin SmartMotor receptacle.

Glenair PN	Description
804-002-06M8-13S	Plug with Accessory Thread, Size 8-13, #23 Sockets. Single key
809-002	#23 Socket, Wire #22 - #28, Material: BeCu, Tool Code: A, C
620MS065M08	Strain Relief Clamp for Series 80 Size 8

The next table provides the tool information for building the mating connector.

Glenair PN	Description	Tool Code
809-088	Insertion/Extraction Tool	
809-015	Adjustable Crimp Tools	A
809-005	Positioner for standard size #23 contacts. #22-#28 AWG. Use with 809-015 crimp tool.	C

These items in the previous tables are available from Glenair, Inc. For further information, see their website at: <http://www.glenair.com>.

LTR-17 Power, Heater and RS-422 Com Cable Diagram

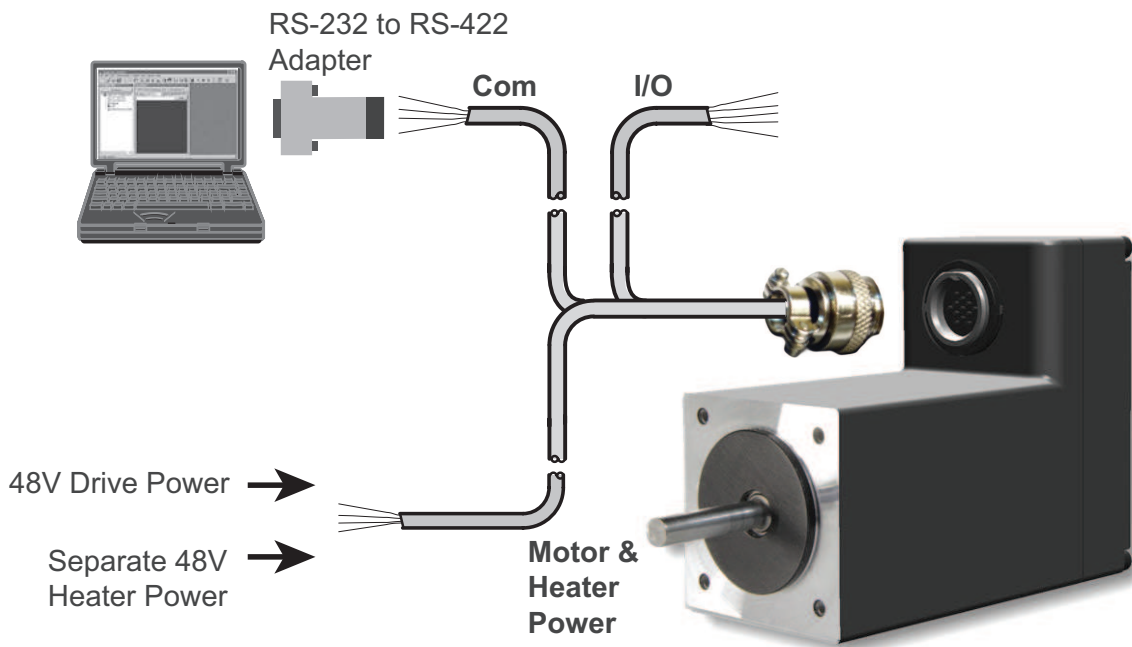

CAUTION: connectors must be finger tightened only! DO NOT use a wrench or other tool. Doing so can cause overtightening of the connection, which may damage the connector and will void the warranty.

NOTE: It is recommended that motor power and heater power have dedicated (separate) power supplies.



CAUTION: It is the user's responsibility to externally control the heater, and warm the board to -40 degrees C or higher to establish communication with the SmartMotor. Only operate the heater between -65 degrees C and 0 degrees C; ensure the heater is off at 0 degrees C. Application of the heater above 0 degrees C can damage the motor.

LTR-23 Motor Connectors and Pinouts

The next figure provides an overview of the connectors and pinouts available on the LTR-23 SmartMotors.

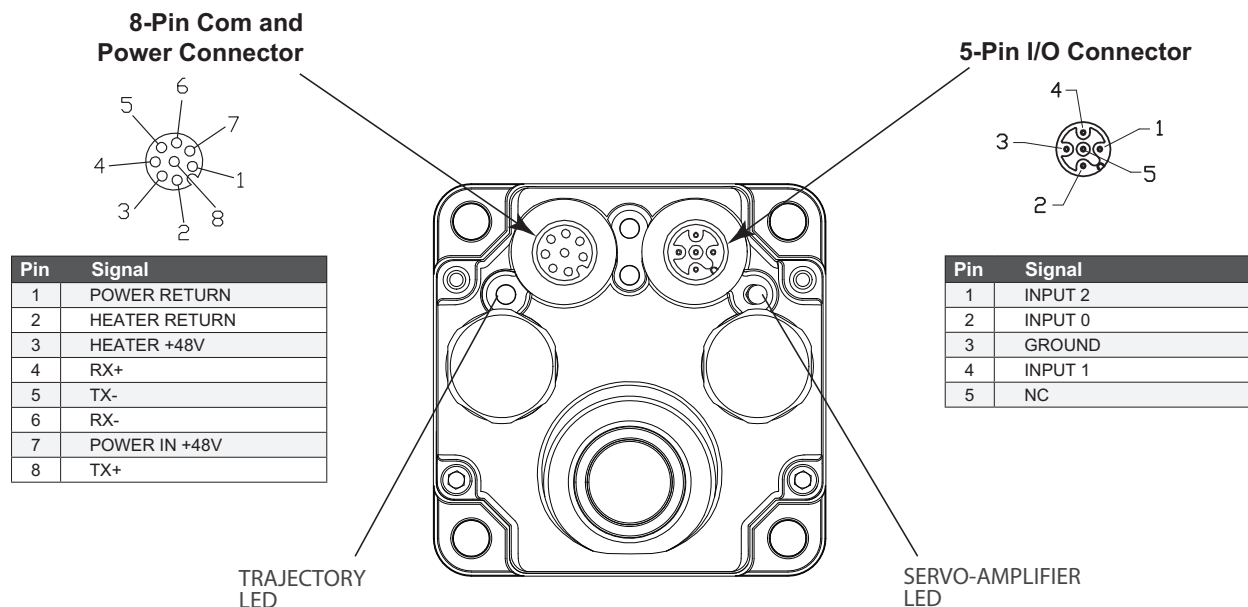

CAUTION: connectors must be finger tightened only! DO NOT use a wrench or other tool. Doing so can cause overtightening of the connection, which may damage the connector and will void the warranty.

Moog Animatics supplies flying-lead cables with connectors at the mating end, which can be purchased for use with the LTR-23 SmartMotors. Refer to the next table.

Moog Animatics PN	Description
CBLIP-CAN-FL	CAN Flying Lead Cable (5-Pin Connector)
CBLIP-COM-FL	COM Flying Lead Cable (8-Pin Connector)

NOTE: These are available with an optional right-angle connector at one end.

The next tables show the pins, wire colors and descriptions for the mating flying-lead cables described in the previous table.

CBLIP-CAN-FL, 5-Pin Connector		
Wire Color	Description	Pin
Bare	Input 2 (5 VDC)	1
Red	Input 0 (5 VDC)	2
Black	Ground (common)	3
White	Input 1 (5 VDC)	4
Blue	No connection	5

CBLIP-COM-FL, 8-Pin Connector		
Wire Color	Description	Pin
White - Blue	Ground (common)	1
White - Brown	Heater return	2
Brown	Heater supply (48V)	3
Orange	RX+	4
White - Green	TX-	5
White - Orange	RX-	6
Blue	Motor supply (48V)	7
Green	TX+	8

LTR-23 Power, Heater and RS-422 Com Cable Diagram

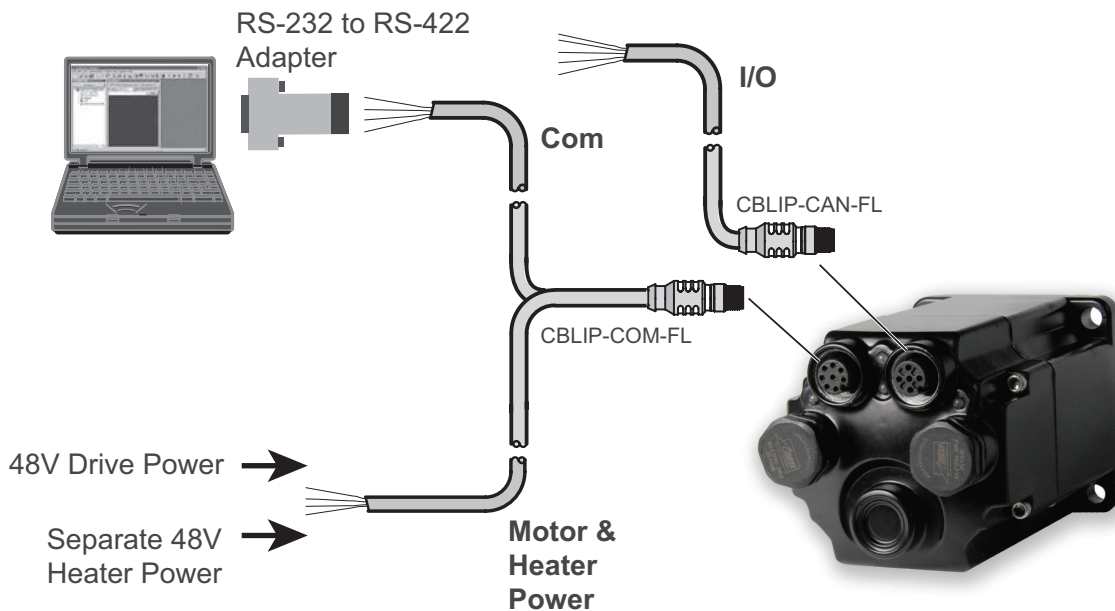

CAUTION: connectors must be finger tightened only! DO NOT use a wrench or other tool. Doing so can cause overtightening of the connection, which may damage the connector and will void the warranty.

NOTE: It is recommended that motor power and heater power have dedicated (separate) power supplies.



CAUTION: It is the user's responsibility to externally control the heater, and warm the board to -40 degrees C or higher to establish communication with the SmartMotor. Only operate the heater between -65 degrees C and 0 degrees C; ensure the heater is off at 0 degrees C. Application of the heater above 0 degrees C can damage the motor.

Maximum Cable Length

For transmission speeds of 200 kilobits/second, RS-422 communications can support shielded cable lengths up to 200 meters. Note that signal rate degrades as the cable length increases.

Understanding the Status LEDs

This section describes the functionality of the Trajectory and Servo-Amp status LEDs on the LTR-17 and LTR-23 SmartMotors.

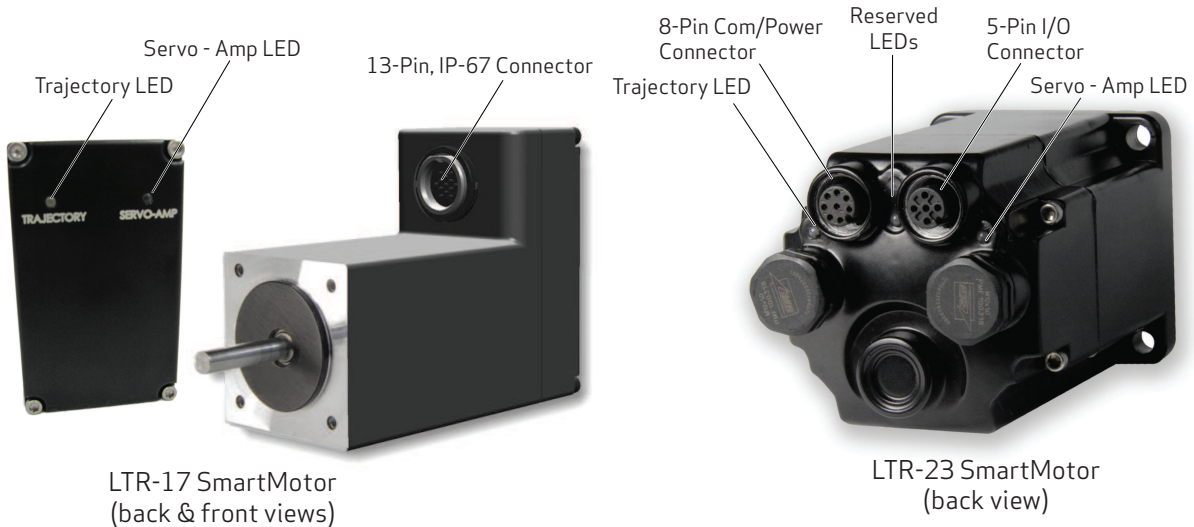

LED 0: Servo - Amp LED	
Off	No power
Solid green	Drive on
Flashing green	Drive off
Flashing red	Watchdog fault
Solid red	Major fault
Alt. red/green	In boot load; needs firmware

LED 1: Trajectory LED	
Off	Not busy
Solid green	Drive on, trajectory in progress

Detecting and Communicating with the SmartMotors

NOTE: The LTR-17 and LTR-23 SmartMotors require firmware version 5.26.3.10 or later.

NOTE: Only one LTR-style motor can be attached to a serial port. The LTR-style motors do not support daisy-chain installation (multiple motors on the same network).

This section describes how to detect and address the LTR-style SmartMotors over the serial network.

This procedure assumes that:

- The SmartMotor is connected to the computer. For details, see Connecting the System on page 28.
- The SmartMotor is connected to a power source. For details, see Understanding the Power Requirements on page 26 and Connecting the System on page 28.
- The SMI software has been installed and is running on the computer. For details, see Installing the SMI Software on page 21.

Understanding the Detection and Configuration Options

There are several ways to use the SMI software to find and address the LTR-style SmartMotors that are connected to your PC:

NOTE: This feature requires connection to the serial port using an RS-422 adapter. The serial port must be configured as RS-232 in SMI.

- Use the Find Motors button—this method is recommended for first-time communications or when you don't know the port used to connect the motors. For details, see Using the Find Motors Button on page 35.
- Use the Detect Motors feature—this method can be used if you know the communications port used to connect your motors and if your motors may be pre-addressed. For details, see Using the Detect Motors Feature on page 38.
- Use the Address Motors feature—this method can be used if you know the communications port used to connect your motors. This method *always* re-addresses the motors; therefore, if you have pre-addressed motors connected, their addresses may be changed. For details, see Detecting and Communicating with the SmartMotors on page 35.

Several of these methods are described in the next sections.

Using the Find Motors Button

NOTE: Only one LTR-style motor can be attached to a serial port. The LTR-style motors do not support daisy-chain installation (multiple motors on the same network).

The easiest way to locate any connected SmartMotor is to use the Find Motors button (see the next figure). This method searches the RS-232 port(s) on the PC for connected motors.

To begin searching for motors on the RS-232 port(s) on the PC, in the Configuration window of the SMI software interface, click Find Motors. The SMI software begins searching for all SmartMotors connected to the PC.

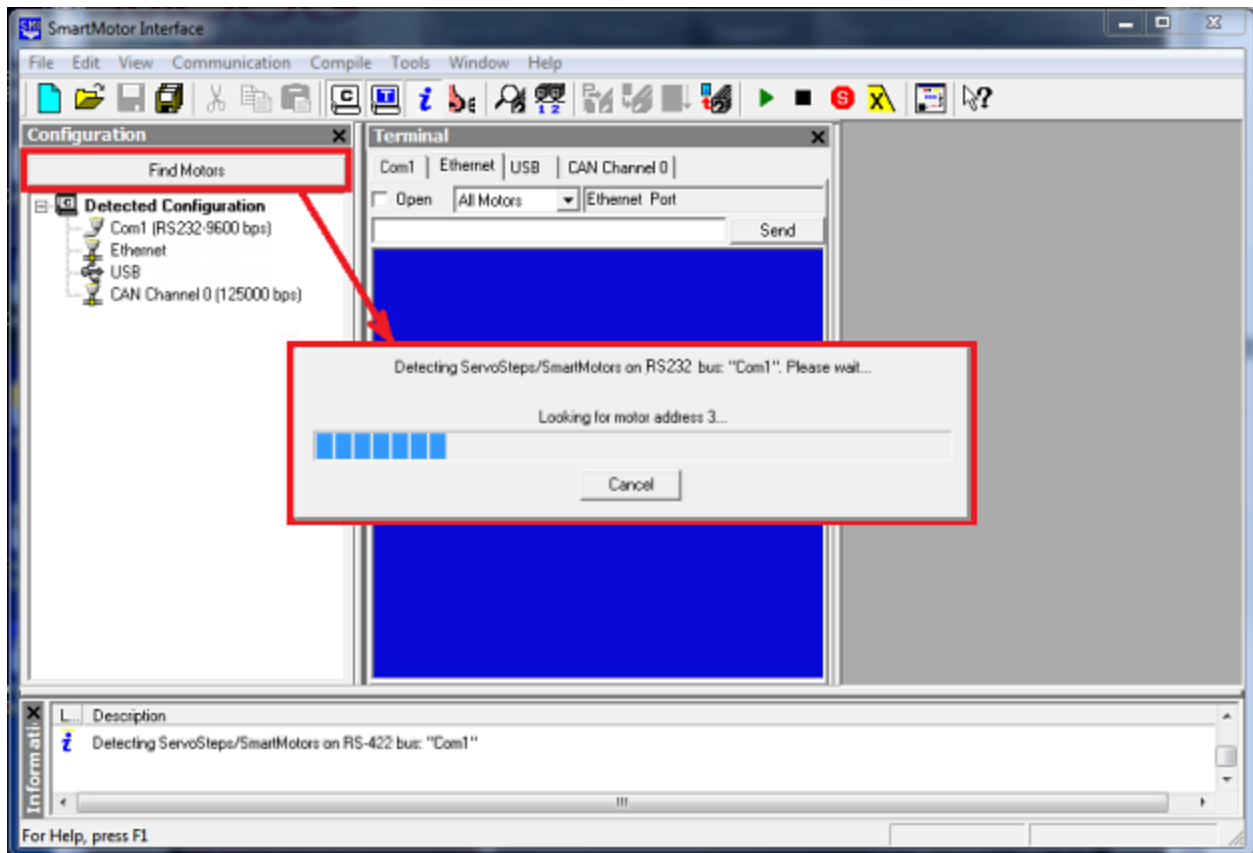

Find Motors Detecting SmartMotors on the RS-232 Bus

After the motors are detected, the SMI software will address them if needed. The next steps are only used when the SMI software finds motors that do not have addresses.

To address the motors, click Yes when you see the following prompt.

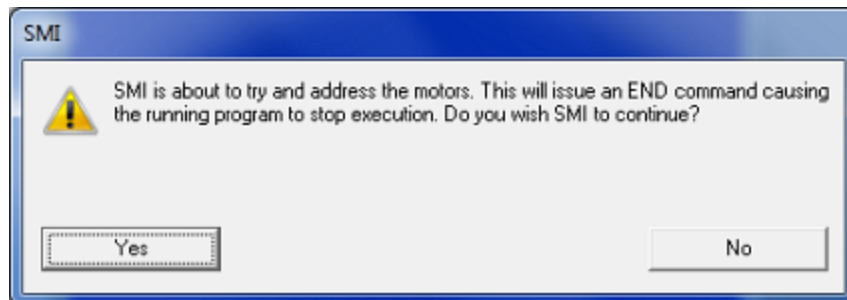

Address the Motors Prompt

A progress bar displays a "Getting motor information" message while the SMI software addresses the motors. During this process, the SMI software is collecting the following information on each motor. The information is the same as that shown in the Motor View window, which can be accessed by selecting the **Tools > Motor View > Info** tab:

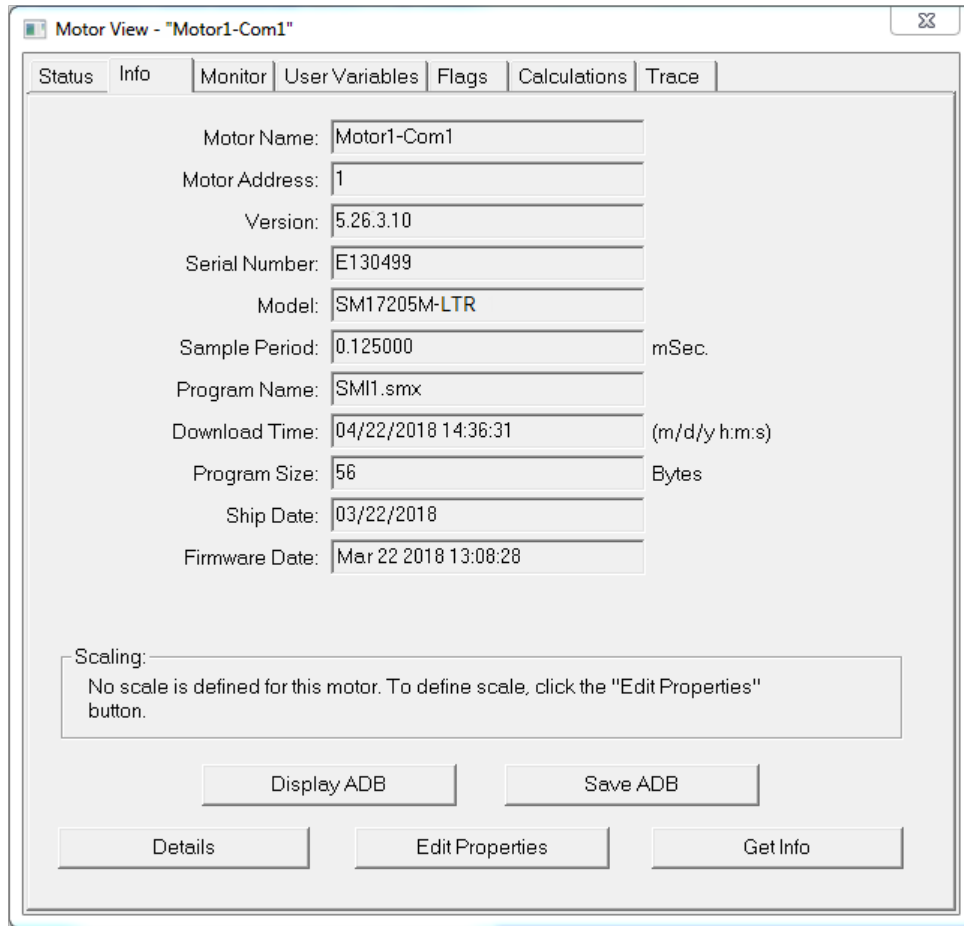

Motor View Information

After the process has completed, the SMI software shows the found motors in the Configuration window under the corresponding communications port. Each motor is represented by a motor icon; the motor's address and firmware version are shown next to the motor icon.

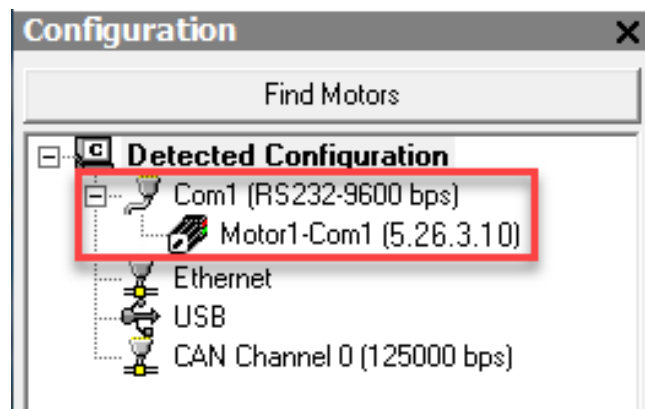

Configuration Window Showing Found/Addressed SmartMotor

Using the Detect Motors Feature

NOTE: Only one LTR-style motor can be attached to a serial port. The LTR-style motors do not support daisy-chain installation (multiple motors on the same network).

This method is similar to the Find Motors method, but it searches only the specified communications port for connected SmartMotors. This is also the recommended method for detecting the motors after they have been pre-addressed and connected to the communications port.

To use the Detect Motors feature, in the Configuration window of the SMI software, right-click the desired communications port and select Detect Motors from the menu.

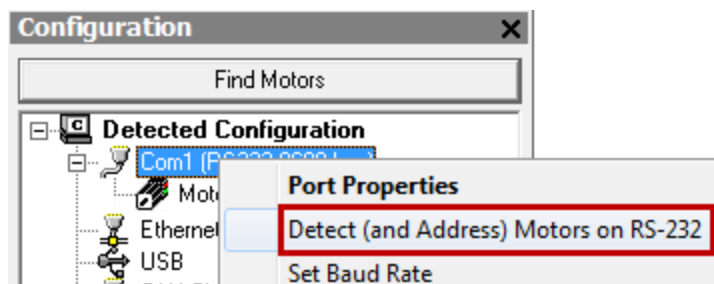

Selecting the Detect Motors Feature

The SMI software begins searching for all SmartMotors connected to the specified communications port. A progress bar is shown while the SMI software searches for the motors.

After the motors are detected, the SMI software will address them if needed. The next steps are only used when the SMI software finds motors that do not have addresses.

To address the motors, click Yes when you see the following prompt.

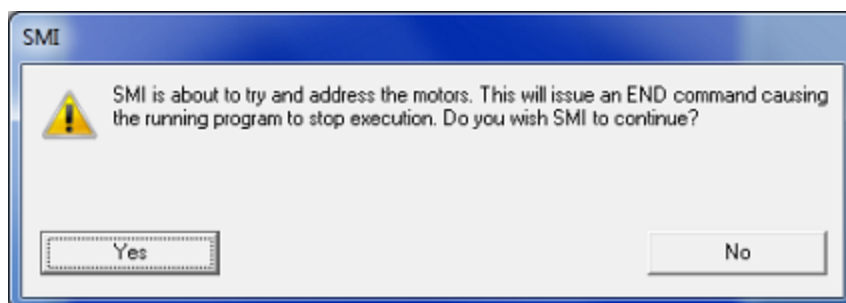

Address the Motors Prompt

A progress bar displays a "Getting motor information" message while the SMI software addresses the motors. During this process, the SMI software is collecting the following information on each motor. The information is the same as that shown in the Motor View window, which can be accessed by selecting the **Tools > Motor View > Info** tab:

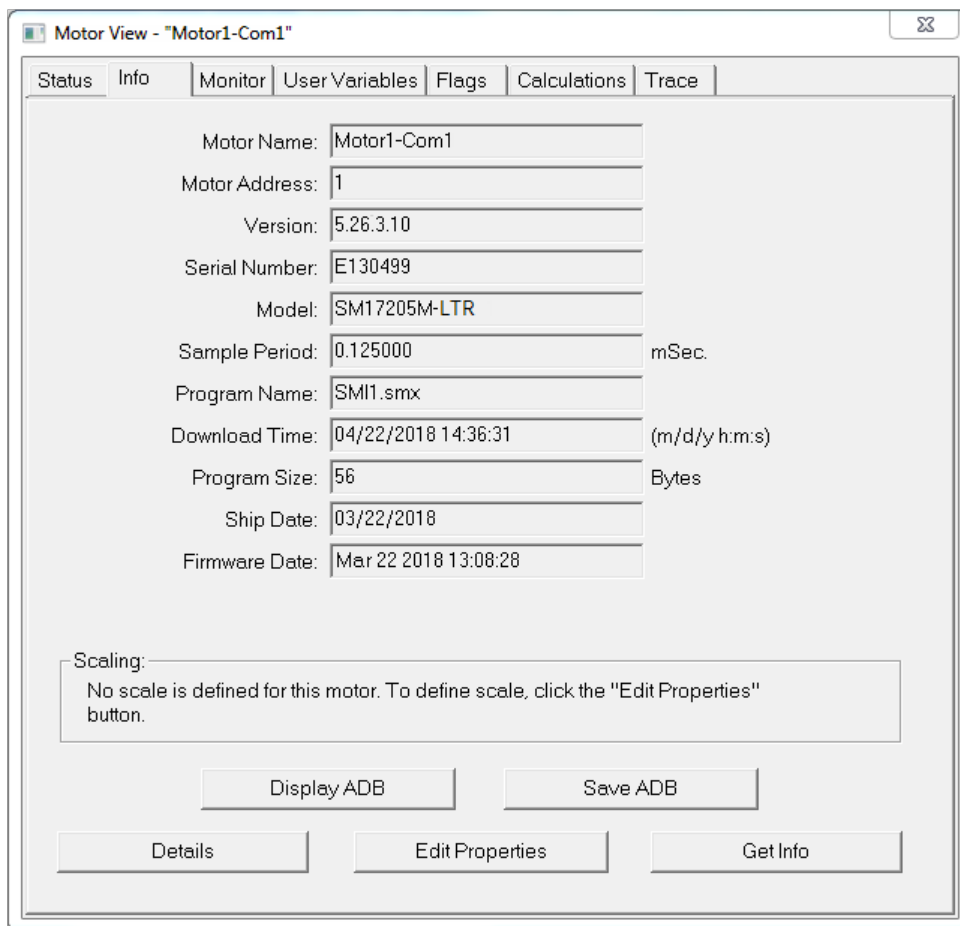

Motor View Information

After the process has completed, the SMI software shows the found motors in the Configuration window under the corresponding communications port. Each motor is represented by a motor icon; the motor's address and firmware version are shown next to the motor icon.

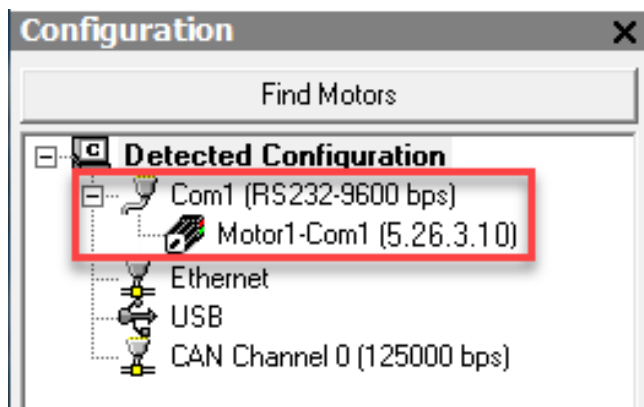

Configuration Window Showing Found/Addressed SmartMotor

Checking and Clearing the Status Bits

NOTE: In addition to the software information in this section, there is context-sensitive help available within the SMI software interface, which is accessed by pressing the F1 key or selecting Help from the SMI software main menu.

The Motor View window is used to view and monitor various motor parameters. It is used in conjunction with the Terminal window to clear any active overtravel limits.

This procedure assumes that:

- The SmartMotor is connected to the computer. For details, see *Connecting the System* on page 28.
- The SmartMotor is connected to a power source. For details, see *Understanding the Power Requirements* on page 26 and *Connecting the System* on page 28.
- The SMI software has been installed and is running on the computer. For details, see *Installing the SMI Software* on page 21.
- The SmartMotor has been detected and addressed.

Polling the Motor

To view the current state of the status bits, you must poll the motor.

1. Double-click the motor icon to open the Motor View window (see the next figure).
2. Click the Poll button to begin polling data from the motor.

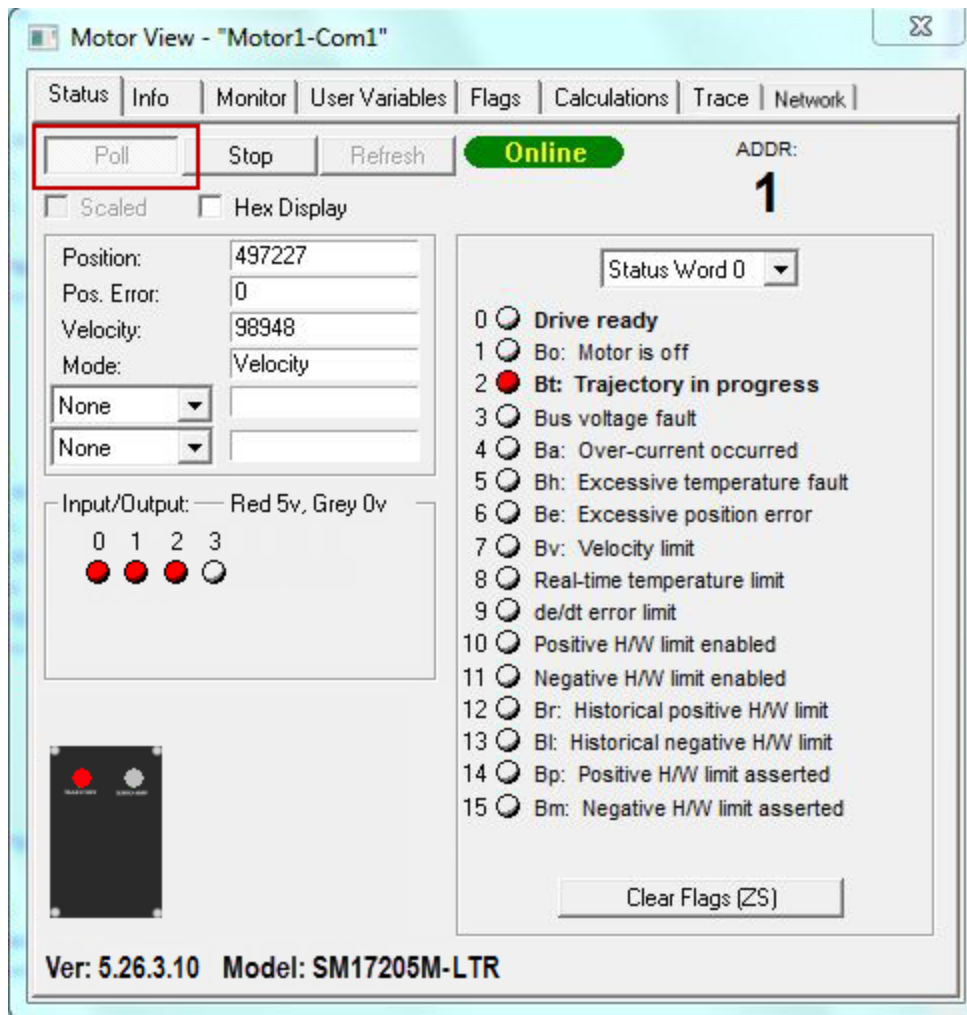

Motor View

A SmartMotor with no program and no I/O connections will boot up with active overtravel limits (see the red status bits numbered 10 through 15 in the previous figure). However, an LTR-style SmartMotor will boot up with no travel limits (the default operation).



CAUTION: An LTR-style SmartMotor will boot up with no travel limits (the default operation).

Clearing the Fault Bits

To clear the historical fault bits, enter ZS. All remaining fault bits are cleared, as shown in the next figures.

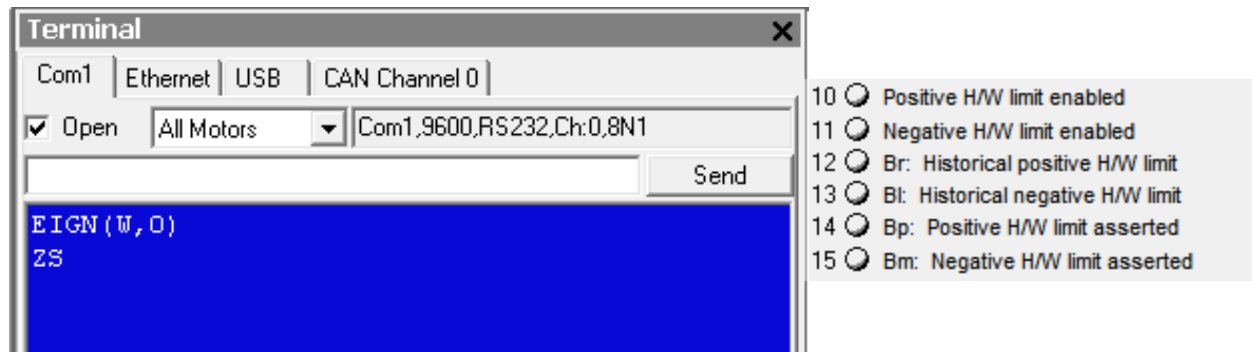

ZS Command Entered

Remaining Bits Cleared

Moving the SmartMotor

NOTE: In addition to the software information in this section, there is context-sensitive help available within the SMI software interface, which is accessed by pressing the F1 key or selecting Help from the SMI software main menu.

The SMI software contains a Torque mode that is used to test the motor response and ensure the drive is operating properly.

This procedure assumes that:

- The SmartMotor is connected to the computer. For details, see Connecting the System on page 28.
- The SmartMotor is connected to a power source. For details, see Understanding the Power Requirements on page 26 and Connecting the System on page 28.
- The SMI software has been installed and is running on the computer. For details, see Installing the SMI Software on page 21.
- The SmartMotor has been detected and addressed. For details, see Detecting and Communicating with the SmartMotors on page 35.
- The fault bits have been cleared. For details, see Checking and Clearing the Status Bits on page 40.

Making the Motor Move



WARNING: The larger SmartMotors can shake, move quickly and exert great force. Therefore, proper motor restraints must be used, and safety precautions must be considered in the workcell design (see Other Safety Considerations on page 6).

To make the SmartMotor move:

1. In the Terminal window, select the tab that matches the communications channel to which your motors are connected. To do this, look at the Configuration window, find the channel where the motors are listed and click that tab name in the Terminal window.

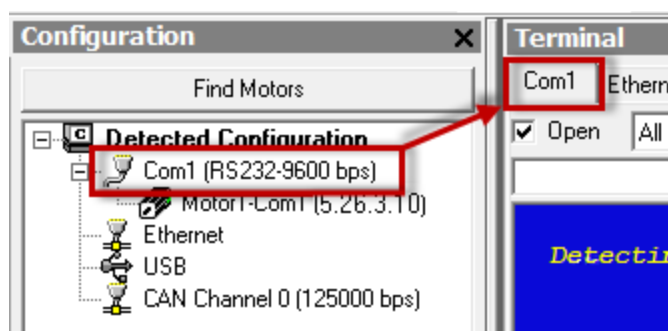

Tab Selected that Matches the Communications Channel

NOTE: If you do not have the correct tab selected, the commands you enter will not go to the motors and there will be no response.

2. Enter these commands in the Terminal window:

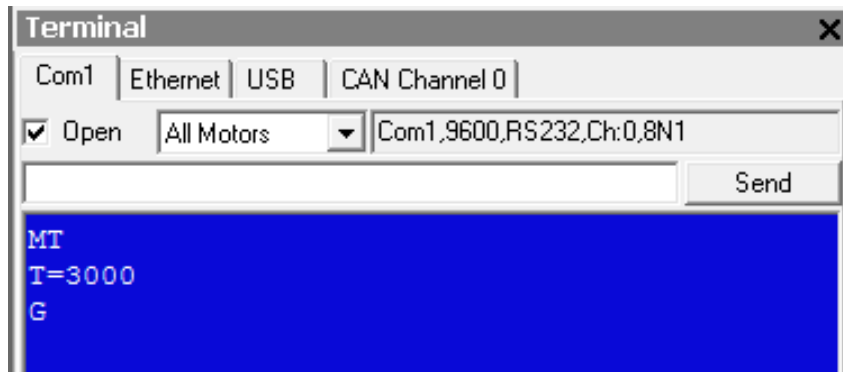

You should immediately see the motor shaft moving in the positive direction (clockwise, when looking at the end of the motor shaft). If the motor does not respond to the commands, see Troubleshooting on page 48 for troubleshooting tips.

NOTE: Macros (shortcut keys) can be used to simplify entry of frequently-used commands. For details, see Macros in the *SmartMotor™ Developer's Guide*.

3. After you have observed the motor shaft turning, enter the X command to decelerate the motor to a stop.

Setting and Reporting Torque

The commands in this section are related to the previous motion procedure. For more details on these commands, see the *SmartMotor™ Developer's Guide*.

MT (Mode Torque)

MT sets the mode of operation to torque mode. In this mode, the SmartMotor shaft applies a torque independent of position. For more details, see Torque Mode in the *SmartMotor™ Developer's Guide*.

T=formula (Set Target Torque)

T can be set to any value from -32767 to +32767, which represents -99.99% to +99.99% PWM (pulse-width modulation) commanded.

RTRQ (Report Actual Torque)

Enter RTRQ at the Terminal window to report the commanded torque from the trajectory generator.

Note that RTRQ typically reports a value that's one less than the T value. In the previous example, T=3000, but RTRQ reports 2999. The value returned by TRQ (and RTRQ) will typically be one less than the T (torque) value due to internal calculations. It may also be reduced in cases where the motor's output is in limitation. TRQ represents the output effort of the motor in both MT (torque mode) and servo modes (MV, MP, etc.). Therefore, it provides a seamless transfer across those modes without causing a ripple or bump in force to the load.

TS (Set Torque Slope)

The TS command defines how fast the processor applies a change in torque. For an example of the TS command, see the Chart View Example in the *SmartMotor™ Developer's Guide*.

Torque slope can range from -1 to 2147483647 (default). At a value of 65536, the processor changes torque by a value of 1 for each PID sample. The default sample rate is; you can view the current sample rate with the RSAMP command.

Checking the Motor Position

There are several ways to check the motor position:

- Report the position using commands from the Terminal window
- View the position in the Motor View tool

These two methods are described in the next sections. You can also view the position in the Monitor or Chart View software tools. For details, see SMI Software Features in the *SmartMotor™ Developer's Guide*.

This procedure assumes that:

- The SmartMotor is connected to the computer. For details, see Connecting the System on page 28.
- The SmartMotor is connected to a power source. For details, see Understanding the Power Requirements on page 26 and Connecting the System on page 28.
- The SMI software has been installed and is running on the computer. For details, see Installing the SMI Software on page 21.
- The SmartMotor has been detected and addressed. For details, see Detecting and Communicating with the SmartMotors on page 35.
- The fault bits have been cleared. For details, see Checking and Clearing the Status Bits on page 40.

Viewing the Motor Position with a Report Command

To report the motor position, in the Terminal window, issue the RPA (Report Position Actual) command:

```
RPA
```

The terminal responds with the current position of the motor:

```
RPA      3593657
```

NOTE: The position is reported on the same line as the command; there is no line feed or carriage return for "report" commands.

The RPA command reports the actual motor position at the time the command was issued. Therefore, it is just a "snapshot"—if the motor is moving, the reported position is not dynamically updated.

Viewing the Motor Position with the Motor View Tool

The Motor View tool provides another way to view the motor position. The advantage of using this tool is that the position is dynamically updated when the motor is moving.

To open the Motor View tool, from the SMI software Configuration window, right-click the motor you want to view and select Motor View from the menu.

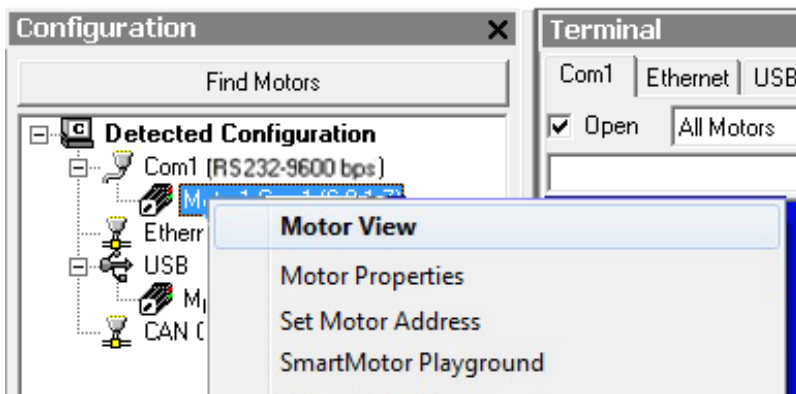

Opening the Motor View Tool

After the Motor View window opens, click the Poll button to begin polling (getting information from) the motor. After polling begins, the motor position is shown in the Position box.

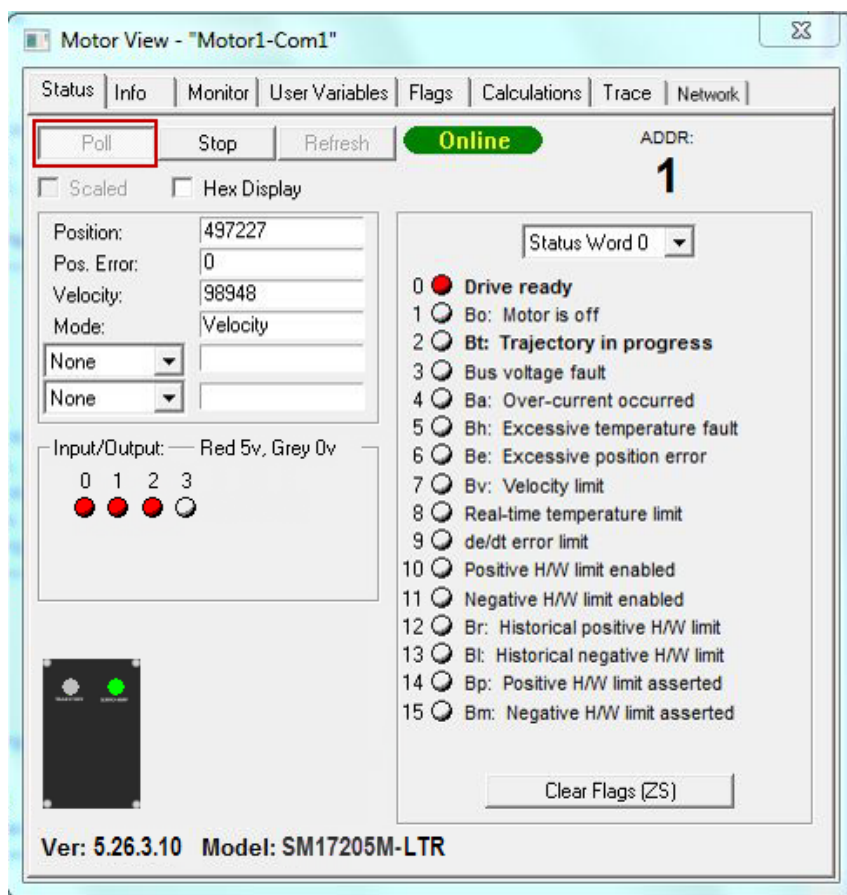

Motor View Tool Showing the Motor Position

Other LTR-Style Changes

In addition, please note these items:

Changes to Commutation Modes

The LTR-style motor uses a magnetic, single-turn absolute encoder. Because of this, the motor does not have to wait for the internal encoder index mark when operating in MDS or MDC commutation modes. This is different from the standard Class 5 SmartMotor. For details on the standard operation, see Commutation Modes in the *SmartMotor™ Developer's Guide*.

Features Not Available

These Class 5 SmartMotor features have *not* been implemented in the LTR-style SmartMotors:

- Daisy-chain installation (multiple motors on the same network)
- Combitronic communications
- Fieldbus communications (CAN, CANopen, DeviceNet, PROFIBUS, etc.)
- I²C communications
- Special "AD1" I/O option (no ROF, ROC commands)
- COM 1 port (second serial port)
- External encoder

Commands Not Currently Supported

These commands are *not* currently supported in the LTR-style SmartMotor:

CAN related: CADDR=, CANCTL, CBAUD=, RCADDR, RCAN, RCBAUD

Sync motion commands (require Combitronic): ADTS, ATS, DTS, GS, PRTS, PRTSS, PTS, PTSS, RPTSD, RPTST, TSWAIT, VTS

Commands associated with the second serial port: BAUD(1)=, CCHN on channel 1, ECHO1, ECHO_OFF1, OCHN on channel 1, PRINT1, RBAUD(1), RGETCHR1, RLEN1, SILENT1, SLEEP1, TALK1, WAKE1

Commands associated with the external encoder: Ai(1), Aij(1), Aj(1), Aji(1), Bi(1), Bj(1), CTR(1), ECS, EIRE, ENC1, I(1), J(1), MC (limited to using SRC(2), SRC(-2)), MF0, MFDIV, MFMUL, MFR (limited to using SRC(2), SRC(-2)), MS0, SRC(1), SRC(-1)

Other: ROC, ROF

For Further Information...

For further information on SMI software features, SmartMotor programming details, communication details, motion details, a complete command reference and more, see the *SmartMotor™ Developer's Guide*.

Troubleshooting

This section provides troubleshooting information for common problems. For additional support resources, see: <http://www.animatics.com/support.html>.

Issue	Cause	Solution
Communication and Control Issues		
Motor control power light does not illuminate.	Control power is off, disconnected or incorrectly wired.	Check that control power is connected to the proper pins and turned on. For connection details, see Connecting the System on page 28.
Motor does not communicate with SMI.	Transmit, receive or ground pins are not connected correctly.	Ensure that transmit, receive and ground are all connected properly to the host PC.
	Motor program is stuck in a continuous loop or is disabling communications.	To prevent the program from running on power up, use the Communications Lockup Wizard located on the SMI software Communications menu.
	Motor circuit board temperature is too cold.	If motor has been in environment of -40 degrees C or below, circuit board may be too cold and internal heater must be activated. For details, see Heater Power Requirements on page 26.
Motor disconnects from SMI sporadically.	COM port buffer settings are too high.	Adjust the COM port buffer settings to their lowest values. This is done In the Windows Device Manager> Advanced Settings dialog box for the associated COM port driver.
	Poor connection on cable from motor to PC.	Check the cable connections and/or replace it.
	Power supply unit (PSU) brownout.	PSU may be undersized for the application, which causes it to brown-out during motion. Make moves less aggressive, increase PSU size or change to a linear unregulated power supply.
Motor stops communicating after power reset, requires redetection.	Motor does not have its address set in the user program. NOTE: Serial addresses are lost when motor power is off or reset.	Use the SADDR or ADDR= command within the program to set the motor address.
Red PWR SERVO light illuminated.	Red LED indicates the drive stage is OFF. This may be due to never having been turned on yet, or a critical shaft protection fault.	To discover the source of the fault, use the Motor View tool located on the SMI software Tools menu.
Motor doesn't turn.	Faults not cleared and/or drive enable not satisfied.	Clear faults (see Checking and Clearing the Status Bits on page 40). Satisfy the drive enable input (see Connecting the System on page 28).
Common Faults		
Bus voltage fault.	Bus voltage is too high for operation.	Check servo bus voltage. Check for excessive regenerative energy from motor due to no/insufficient shunt resistor.
	Bus voltage is too low for operation.	If motor uses the (separate drive and control power supplies), ensure that both power supplies are connected and are sized correctly for the motor.
Overcurrent occurred.	Motor intermittently drew more than its rated level of current. Does not cease motion.	Consider making motion less abrupt with softer tuning parameters or lower acceleration profiles.

Troubleshooting

Issue	Cause	Solution
Excessive temperature fault.	Motor has exceeded internal PCB temperature limit of 85°C. Motor will remain unresponsive until it cools down below 80°C.	Motor may be undersized or ambient temperature is too high. Check motor sizing for the application in terms of continuous rating. Consider adding heat sinks or forced air cooling to the system.
Excessive position error.	The motor's commanded position and actual position differ by more than the user-supplied error limit.	Increase error limit, decrease load or make movement less aggressive. Also, ensure you are not voltage limited for the torque at speed required. If running from less than 48 VDC, check ratings for lower bus voltages and ensure the motor is within required torque capacity.
Motor faults on position error only after a certain amount of time.	Motor sized incorrectly.	Check motor sizing for the application in terms of continuous rating. Also, ensure you are not voltage limited for the torque at speed required. If running from less than 48 VDC, check ratings for lower bus voltages and ensure the motor is within required torque capacity.
Motor is not accurately corresponding to trajectory.		
Historical positive/negative hardware limit faults.	A limit switch was tripped in the past.	Clear errors with the ZS command.
	Motor does not have limit switches attached.	Configure the motor to be used without limit switches by setting their inputs as general use.
Programming and SMI Issues		
Several commands not recognized during compiling.	Compiler default firmware version set incorrectly.	Use the Compiler default firmware version option in the SMI software Compile menu to select a default firmware version closest to the motor's firmware version. In the SMI software, view the motor's firmware version by right-clicking the motor and selecting Motor Properties.

TAKE A CLOSER LOOK

Moog Animatics, a sub-brand of Moog Inc. since 2011, is a global leader in integrated automation solutions. With over 30 years of experience in the motion control industry, the company has U.S. operations and international offices in Germany and Japan as well as a network of Automation Solution Providers worldwide.

Americas - West
Moog Animatics
2581 Leghorn Street
Mountain View, CA 94043
United States

Americas - East
Moog Animatics
1995 NC Hwy 141
Murphy, NC 28906
United States

Europe
Moog GmbH
Memmingen Branch
Allgaeustr. 8a
87766 Memmingerberg
Germany

Asia
Moog Animatics
Kichijoji Nagatani City Plaza 405
1-20-1, Kichijojihoncho
Musashino-city, Tokyo 180-0004
Japan

Tel: +1 650-960-4215
Email: animatics_sales@moog.com

Tel: +49 8331 98 480-0
Email: info.mm@moog.com

Tel: +81 (0)422 201251
Email: mcg.japan@moog.com

For Animatics product information, visit www.animatics.com

For more information or to find the office nearest you, email animatics_sales@moog.com

Moog is a registered trademark of Moog Inc. and its subsidiaries.
All trademarks as indicated herein are the property of Moog Inc. and its subsidiaries.
©2014-2023 Moog Inc. All rights reserved. All changes are reserved.

Moog Animatics LTR-Style SmartMotor™ Installation and Startup Guide,
Rev. E, March 2023, PN: SC80100008-001